

*Baja Marine*  
*Owner's Manual*



H2X



Owner's Manual Part Number: MRP 1813657  
© Baja Marine Corporation 2006

---



BAJA MARINE CORPORATION, 2600 SEA RAY BLVD., KNOXVILLE, TN 37914  
FOR INFORMATION CALL 1-865-971-6270 OR FAX 1-865-971-6716

INTERNET ADDRESS: [HTTP://WWW.BAJAMARINE.COM](http://www.bajamarine.com)

---

# WELCOME

---



Congratulations on becoming the new owner of the world's #1 performance boat. Baja® Marine Corporation welcomes you into our worldwide and ever-expanding family of boating enthusiasts.

The Owner's Manual Packet, to be kept on board your Baja, gives you important information on the features of your Baja. Take the time to carefully review the information in your Owner's Manual Packet and really get to know your boat. **Everyone that operates the boat should read this manual.**

The Owner's Manual Packet contains the following:

- **Owner's Manual:** The Owner's Manual gives you important operating and safety information, as well as reminders about your responsibilities as a boat owner/operator.

- **Original Equipment Manufacturer (OEM) Information:** This section of your Owner's Manual Packet contains information from the manufacturers of equipment installed on your boat. Examples include the engine, engine control and steering system. Throughout the Owner's Manual you will be referred to information provided by manufacturers of specific systems.

Because your purchase represents a substantial investment, we know you will want to take the necessary measures to protect its value. We have outlined a program for proper operation, periodic maintenance and safety inspections. We urge you to follow these recommendations. If you have questions which are not fully covered by the Owner's Manual Packet, please consult your authorized dealer for assistance.

*Thank You For Selecting A Baja®!*



THIS PAGE INTENTIONALLY LEFT BLANK

---

# INTRODUCTION

---

## 1. THIS MANUAL

The material within this manual and your Owner's Manual Packet:

- Gives you basic safety information
- Describes the features of your boat
- Describes the equipment on your boat
- Describes the fundamentals of boat use
- Contains service and maintenance information

**You must learn to operate this boat as well as read, understand and use this manual.**

What this manual does not give you is a course in boating safety, or how to navigate, anchor, or dock your boat. Operating a power boat safely requires more skills, knowledge, and awareness than is necessary for a car or truck.

## 2. YOUR RESPONSIBILITIES

For your safety, the safety of your passengers, other boaters, and people in the water, you must:

- Take a boating safety course
- Get instruction in the safe and proper handling of your boat
- Understand and follow the "Rules of the Road"
- Learn how to navigate
- Registration: In addition to the registration requirements for your boat in the state where it is used most frequently, many states require additional registration when an out-of-state boat is used within their boundaries. Contact state boating authorities or any marine dealer for registration requirements.

## 3. SOURCES OF INFORMATION

In North America, contact one of the following for boating courses:

- U.S. Coast Guard Auxiliary
- U.S. Power Squadron
- Canadian Power and Sail Squadrons

- Red cross
- State Boating Offices
- Yacht Club

Contact your dealer or the Boat/U.S. Foundation at 1-800-336-2628

Outside of North America, contact your boat dealer and/or your governmental boating agency for assistance.

A book that provides a comprehensive background in boating is Chapman Piloting, Seamanship and Small Boat Handling, by Elbert S. Maloney, published by Hearst Marine.

## 4. DEALER RESPONSIBILITIES

In addition to a pre-delivery check and service of the boat, your dealer is to give you:

- A description and demonstration of the safety systems, features, instruments, and controls on your boat
- An orientation in the general operation of your boat
- An "In Service Form" completed by you and the dealer after inspection of the boat
- A review of all warranty information and how to obtain warranty service
- The complete Owner's Manual Packet

If you do not receive all of these materials, or have any questions, contact your dealer or call: 1-865-971-6270.

## 5. WARRANTIES

Each component and/or system on your boat has its own warranty that will be found with the specific information and manual for that component. These are included with your Owner's Manual Packet. Locate and read the individual warranties; then put them together for easy future reference. The Baja® warranty is on the warranty information card in your packet and is repeated in this section.

---

# INTRODUCTION

---

## 6. HULL IDENTIFICATION NUMBER (HIN)

The “Hull Identification Number” located on the starboard side of the transom, is the most important identifying factor and must be included in all correspondence and orders. Failure to include it creates delays. Also of vital importance are the engine serial numbers and part numbers when writing about or ordering parts for your engine. Refer to the Engine Operator’s Manual for locations of engine serial numbers and record them for future reference.

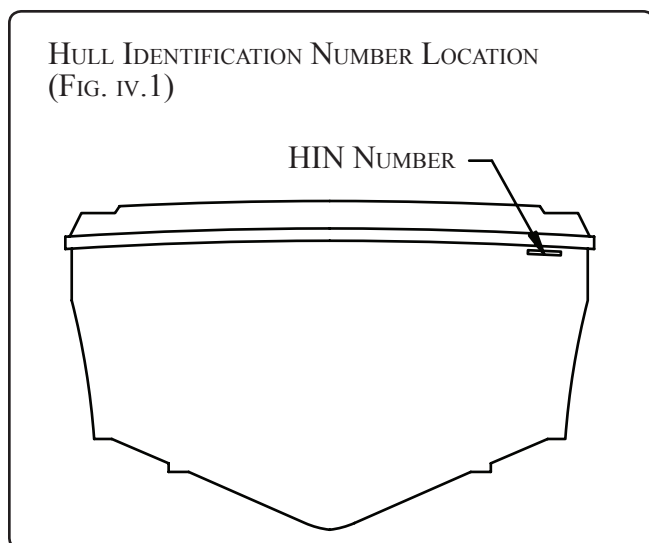

## 7. MANUFACTURER’S CERTIFICATION

As a boat manufacturer, Baja builds its products to guidelines established under the Federal Boat Safety Act of 1971. The Act is promulgated by the United States Coast Guard who has authority to enforce these laws on boat manufacturers that sell products in the United States. Baja ensures that all of its products comply with these laws.

The National Marine Manufacturers Association (NMMA) provides Baja with a third party certification. The NMMA is an organization that represents the marine industry and assists manufacturers, boat dealers, marinas, repair yards, and component suppliers in areas of legislation, environmental concerns, marine business growth, and state and federal government agency interaction. The third party certification that Baja participates in uses the well known Standards and Recommended Practices of the ABYC, American Boat and Yacht Council.

Baja Marine Corporation participates extensively in the American Boat and Yacht Council which is a nonprofit organization that develops and publishes voluntary standards and recommended practices for boat and equipment design, construction, service, and repair. We utilize all applicable ABYC standards in the construction of our boats.

Finally, Baja sells their products world wide and as such must conform to the various rules and regulations required by other countries. Most notably, are the ISO standards in Europe which require the application of the CE (Common European) mark. This mark, much like the NMMA certification in the U.S., gives you, the boat owner, specific information concerning your craft.

## 8. SERVICE, PARTS AND REPAIR FOR YOUR BOAT

When your boat needs service, parts or repair, take it to an authorized Baja® Marine dealer. To find a dealer in your area visit our website at [www.bajamarine.com](http://www.bajamarine.com) or call:

Domestic/International  
1-865-971-6270  
Fax: 1-865-971-6716

To find repair and parts facilities for the equipment installed on your boat, refer to the manual for that component.

If an issue is not handled to your satisfaction:

1. Discuss any warranty-related issues directly with the service manager of the dealership or your sales person. Give the dealer an opportunity to help the service department resolve the matter for you.
2. If an issue arises that has not been resolved to your satisfaction by your dealer, contact Baja® Marine at 1-865-971-6270 and ask to speak with a customer service representative.



## ABOUT YOUR EXPRESS LIMITED WARRANTY

Baja Marine offers an Express Limited Warranty on each new Baja purchased through an authorized Baja dealer. A copy of the Limited Warranty was included in your owner's packet. If for any reason you did not receive a copy of the Limited Warranty, please contact your local dealer or call 1-865-971-6270 for a replacement copy. \* This is a summary of several provisions of the Limited Warranty. Please read the Limited Warranty, which is the controlling document.

Under the Limited Warranty, Baja Marine covers structural fiberglass deck or hull defects which occur within five (5) years of the date of delivery and parts found to be defective in factory material or workmanship within one (1) year of the date of delivery. In addition, laminate blisters resulting from defects in factory material or workmanship are covered for three (3) years from the original date of purchase, or for four (4) years from date of manufacture.

Baja's obligation under the Limited Warranty is limited to repair or replacement of parts that are judged defective by Baja Marine and does not include transportation, haul out, or other expenses. The foregoing is the sole and exclusive remedy provided by Baja Marine.

The Limited Warranty does not cover engines, stern drives, controls, propellers, batteries, trailers, or

other equipment or accessories carrying their own individual warranties, nor does the Limited Warranty cover engines, parts or accessories not installed by Baja Marine. The Limited Warranty does not cover cosmetic gel coat finish. Boats used for commercial purpose are excluded from coverage. See the Baja Marine Express Limited Transferable Warranty for other exclusions.

**BAJA MARINE EXPRESSLY DISCLAIMS THE IMPLIED WARRANTIES OF MERCHANTABILITY AND FITNESS. NEITHER BAJA MARINE NOR THE SELLING DEALER SHALL HAVE ANY RESPONSIBILITY FOR LOSS OF USE OF THE BOAT, LOSS OF TIME, INCONVENIENCE, COMMERCIAL LOSS OR CONSEQUENTIAL DAMAGES.**

The unexpired term of the Limited Warranty may be transferred to a new owner upon the new owner's written request to Baja Marine Corporation, 2600 Sea Ray Blvd., Knoxville, TN 37914 and accompanied by the payment to Baja Marine Corporation of fifty dollars (\$50.00).

Thank you for your decision to buy a Baja.

\* The Baja Marine Express Limited Transferable Warranty is subject to change at any time at Baja's discretion. The information contained herein is general information about the Limited Warranty for the owner's general knowledge, but does not alter or amend the terms of the Limited Warranty.

---

# H2X OWNER'S MANUAL • TABLE OF CONTENTS

---

## INTRODUCTION

1. This Manual .....iii
2. Your Responsibilities .....iii
3. Sources of Information .....iii
4. Dealer Responsibilities .....iii
5. Warranties .....iii
6. Hull Identification Number (HIN)..... iv
7. Manufacturer's Certification..... iv
8. Service, Parts and Repair for Your Boat..... iv
- About Your Express Limited Warranty ..... v

## SECTION 1 • SAFETY

1. Safety Labels..... 1.1
2. Legally Mandated Minimum Required Equipment ..... 1.2
3. Fire Extinguishing System ..... 1.2
4. Carbon Monoxide ..... 1.2
5. Lifesaving Equipment ..... 1.4
6. Additional Recommended Equipment for Safe Operation ..... 1.5
7. Impaired Operation..... 1.5
8. Load Capacity..... 1.5
9. Power Capacity ..... 1.6
10. Stability ..... 1.6
11. Maintain Control..... 1.7
12. Weather ..... 1.7
13. Chart Your Course ..... 1.8
14. Water Sports..... 1.9
  - A. Swimming ..... 1.9
  - B. Skiing ..... 1.9
  - C. Diving ..... 1.10
15. Emergency Situations..... 1.10
  - A. Medical Emergency ..... 1.10
  - B. Water Rescue ..... 1.10
  - C. Fire ..... 1.11
  - D. Flooding, Swamping and Capsizing ..... 1.11
  - E. Collisions and Leaking..... 1.11
  - F. Grounding ..... 1.12
  - G. Propulsion, Control or Steering Failure ..... 1.12
16. Safety Hotlines ..... 1.12
17. International Requirements ..... 1.12
18. Environmental Considerations..... 1.13
  - A. Fuel and Oil Spillage ..... 1.13
  - B. Waste Disposal ..... 1.13
  - C. Excessive Noise ..... 1.13
  - D. Wake/Wash ..... 1.13
19. Nautical Terms..... 1.14
20. Key to Symbols on Controls & Prints ..... 1.15
21. Warning Label Locations ..... 1.17

## SECTION 2 • GENERAL BOAT ARRANGEMENT

1. Docking/Lifting/Trailing ..... 2.1
2. Passenger Locations ..... 2.1
3. Basic Boat Dimensions and Clearances (United States Standard S.A.E.) ..... 2.2
4. Propulsion System..... 2.3
5. Propellers ..... 2.3
6. General Deck Layout..... 2.4
7. Description of Major Controls ..... 2.5
  - A. Gear Shift and Throttle Control..... 2.5
  - B. Power Trim Unit and Gauge ..... 2.5
  - C. Trailer Switch ..... 2.6
  - D. Trim Tabs ..... 2.6
  - C. Ignition Shutdown Switch ..... 2.7
  - D. Engine Alarm System ..... 2.7
8. Important Gauges..... 2.7
  - A. Tachometer and Hour Meter ..... 2.7
  - B. Oil Pressure, Water Temperature, Voltmeter and Fuel Gauges..... 2.8
9. Navigation and Anchor Lights..... 2.8

## SECTION 3 • USING YOUR BOAT

1. Pre-Launch, Launch and Post-Launch Checklist 3.1
2. Trailer Launching and Loading ..... 3.2
3. Fueling the Boat ..... 3.2
4. Boarding ..... 3.3
5. Personal Flotation Devices (PFD's)..... 3.3
6. Passenger Instruction and Location ..... 3.4
7. Starting the Engine ..... 3.4
8. Shifting to Drive the Boat..... 3.5
9. Stopping the Engine ..... 3.5
10. Steering System ..... 3.6

## SECTION 4 • BILGE & UNDERWATER GEAR

1. Bilge..... 4.1
  - A. Fuel & Oil Spillage ..... 4.1
  - B. Drain Plug ..... 4.1
  - C. Bilge Pumps ..... 4.1
  - D. Bilge Blower(s) ..... 4.2
2. Engines and Stern Drive..... 4.2
  - A. Maintenance and Service ..... 4.2
  - B. Vibration and Causes ..... 4.2
  - C. Impact to Stern Drive..... 4.3
  - D. Propeller Removal and Installation..... 4.3



---

# H2X OWNER'S MANUAL • TABLE OF CONTENTS

---

## SECTION 5 • FUEL SYSTEM

- 1. Fuel System..... 5.1
- 2. Fueling Precautions..... 5.2
  - A. Static Electricity and the Fuel System ..... 5.2
  - B. General:..... 5.2
  - C. Before and During Fueling – Checklist:..... 5.2
  - D. After Fueling – Checklist:..... 5.3

## SECTION 6 • ELECTRICAL SYSTEMS

- 1. Electrical Systems ..... 6.1
  - A. Batteries ..... 6.1
  - B. Ignition Protection..... 6.1
  - C. Breakers and/or Fuses ..... 6.2
  - D. Fuse Panel ..... 6.2
- 2. Electrolytic Corrosion & Zinc Anodes ..... 6.2
- 3. Marine Electronic Cathodic Anti-corrosion System (Mercathode®) ..... 6.3
- 4. Electrical Systems ..... 6.3

## SECTION 7 • OPTIONS & ACCESSORIES

- 1. Options & Accessories Locations ..... 7.1
- 2. Automatic Fire Extinguisher System (Option)..... 7.2
- 3. Fire Extinguisher Port..... 7.2
- 4. Canvas ..... 7.2
  - A. Canvas Care and Maintenance ..... 7.3
  - B. Trailering With Canvas ..... 7.3
- 5. Horn..... 7.3
- 6. Swim Platform w/ Ladder ..... 7.3
- 7. Depth Finder (Optional)..... 7.3
- 8. Stereo System..... 7.4
- 9. Head Systems ..... 7.4
  - A. Requirements for Operators ..... 7.4
  - B. Portable Head with Pump-Out..... 7.4
  - C. Holding Tank Operation ..... 7.5
  - D. Vent Filter ..... 7.5

## SECTION 8 • REQUIRED INSPECTION, SERVICE, & MAINTENANCE

- 1. Summary Guide for Inspection, Service and Maintenance..... 8.1
- 2. Useful Service Information ..... 8.3
- 3. Inspection, Service and Maintenance Protocol ... 8.4
  - A. Bilge Area ..... 8.4
  - B. Topside and Supplies..... 8.5
- 4. Winterization Checklist for Boats Stored on Land8.5
  - A. Boat Storage..... 8.5
  - B. Engine ..... 8.5
  - C. Battery(ies)..... 8.5
  - D. Fuel Systems..... 8.6
- 5. Fitting Out After Storage ..... 8.6
  - A. Fuel System..... 8.6
  - B. Battery(ies) ..... 8.6
  - C. Miscellaneous..... 8.6
- 6. Security Considerations..... 8.7
- 7. Power Steering System Maintenance ..... 8.7
- 8. Quick Reference Checklist ..... 8.8
  - A. Boarding the Boat\* ..... 8.8
  - B. Preparing to Depart and After Launching ..... 8.9
  - C. Departing ..... 8.10
  - E. Securing the Boat ..... 8.11
  - F. If the Engine Does Not Start ..... 8.11
- 9. After Market Equipment Checklist ..... 8.12
- 10. Maintenance Log..... 8.13

## SECTION 9 • CARE & REFINISHING

- 1. Paint Cleaning Agents & Other Substances ..... 9.1
- 2. Fiberglass & Gelcoat ..... 9.1
- 3. Stains & Scratches ..... 9.1
- 4. Permanently Moored or Docked Boats..... 9.2
- 5. Topside Areas ..... 9.2
  - A. Stainless Steel and Alloy Fittings..... 9.2
  - B. Salt Crystals ..... 9.2
- 6. Acrylic Plastic Sheeting (Plastic Glass) ..... 9.2
- 7. Canvas and Clear Vinyl ..... 9.2
- 8. Exterior Upholstery Fabric ..... 9.3
- 9. Interior Upholstery Fabric ..... 9.3

## INDEX

Information in this publication is based upon the latest product specifications available at printing. Baja® Marine Corporation reserves the right to make changes at any time, without notice, in the colors, equipment, specifications, materials and prices of all models, or to discontinue models. Should changes in production models be made, Baja® Marine is not obligated to make similar changes or modifications to models sold prior to the date of such changes.

Owner's Manual

H2X

Printed in the U.S.A. January 2006

© Baja Marine Corporation • A Brunswick Company

**MRP #1813657**

Baja Marine Corporation 2600 Sea Ray Blvd., Knoxville, TN 37914

For information call 1-865-971-6270 or fax 1-865-971-6716

Internet Address: <http://www.bajamarine.com>

Baja®, , and Speed changes you.™ are registered trademarks of the Brunswick Corporation.



---

# SECTION 1 • SAFETY

---

## SAFE boating means:

- Knowing the limitations of your boat
- Following the "Rules of the Road"
- Keeping a sharp lookout for people and objects in the water
- Not boating in water or weather conditions that are beyond the boat's and the operator's capability
- Never boating when the operator is under the influence of drugs or alcohol
- Being aware of your passenger's safety at all times
- Reducing speed when there is limited visibility, rough water, and nearby people in the water, boats, or structures

Boating in beautiful weather and calm water conditions can be a wonderful experience. Pleasurable boating, however, requires considerably greater skills than operating a land vehicle. To obtain these skills, you must:

- Take a Coast Guard, U.S. Power Squadron or equivalent boating safety course. Call the Boat/U.S. Foundation at 1-800-336-2628 for information on available courses.
- Get hands-on training on how to operate your boat properly.

In addition:

- Maintain your boat and its safety and other systems as recommended in this manual.
- Have the boat inspected by a qualified mechanic or dealer, at least annually.
- Ensure that the Coast Guard required safety equipment is on board and functions properly. (See page 1.2)

## 1. SAFETY LABELS

Safety precautions are given throughout this manual and labels are mounted at key locations throughout the boat. This safety information advises the owner/operator and passengers of imperative safety precautions to follow when operating and/or servicing equipment.

- Do not remove or obstruct any safety label.
- Replace any label which becomes illegible. Replacement safety labels can be obtained by calling your dealer or Baja Marine at 1-865-971-6270.

The meanings associated with each of the four basic types of labels are:

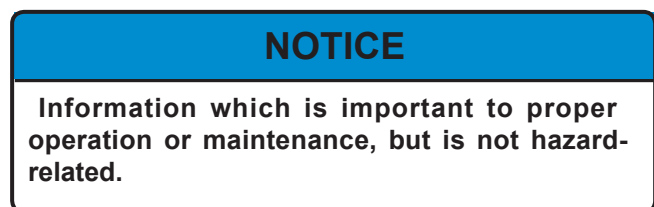

# SECTION 1 • SAFETY

## 2. LEGALLY MANDATED MINIMUM REQUIRED EQUIPMENT

**Consult your national or state boating law enforcement agency.**

The following equipment is the minimum required by the U.S. Coast Guard for a boat less than 26' [7.9 meters] in length.

**Personal Flotation Devices (PFDs):** One Coast Guard approved Type I, II or III device is mandatory for each person aboard. One throwable Type IV device is also required to be on board. A Type V device is acceptable if worn for approved use. See Page 1.4 for a description of these PFD classifications. **Always wear a PFD when boating.**

**Fire Extinguisher - Portable:** If no fixed fire extinguishing system is installed in the engine and generator spaces, the U.S. Coast Guard requires **one (1) Type B1** fire extinguisher be on board. The American Boat and Yacht Council (ABYC) recommends that you have **two (2) Type ABC** fire extinguishers on board. One is to be located at the helm station and the other in the cabin, near the cockpit door.

**Whistle, Horn:** You must have on board some means of making a loud sound signal, for example, whistle or horn.

**Visual Distress Signals:** If you operate your boat in coastal waters or on the Great Lakes, you must have visual distress signals for day and night use on board. At least three (3) U.S. Coast Guard approved pyrotechnic devices, marked with date showing service life, must be carried, be readily accessible, in serviceable condition and not expired. Store pyrotechnic signals in a well-marked waterproof container in a dry location.

**Other:** Your Baja boat is equipped with the required navigation lights, engine exhaust and ventilation systems.

## 3. FIRE EXTINGUISHING SYSTEM

Your boat may be equipped with the optional automatic fire extinguisher system, located in the engine compartment. In the event of a fire, the heat sensitive automatic head in the engine compartment will release a fire-extinguishing vapor, totally flooding the area.

The dashboard contains an indicator light for the automatic fire extinguishing system. The light will be ON when the ignition is on and indicates that the system is ready. If the light goes out while the ignition is on, the system has discharged.

**When discharge occurs, immediately shut down all engines, powered ventilation, electrical systems and extinguish all smoking materials. Do not immediately open the engine compartment! This feeds oxygen to the fire and the fire could restart.**

Wait at least fifteen (15) minutes before opening the engine compartment. This permits the fire-extinguishing vapor to "soak" the compartment long enough for hot metals and fuels to cool. Have portable extinguishers at hand and ready to use in case the fire re-ignites. Do not breathe fumes or vapors caused by the fire.

## 4. CARBON MONOXIDE

**⚠ DANGER**

Fumes from engines, generators, and other equipment and appliances using burning fuel contain odorless, colorless carbon monoxide gas.

Carbon monoxide can cause brain damage or death.

Open all doors, curtains, windows, and hatches to let fresh air circulate, when running engine, generator or burning any fuel when boat is anchored, moored or docked.

**⚠ DANGER**

In rainy and/or cold weather, fresh air must circulate through boat to avoid carbon monoxide poisoning.

**⚠ DANGER**

Sleeping on boat requires an operating Carbon Monoxide detection system in each sleeping location.

Symptoms of carbon monoxide poisoning are dizziness, ears ringing, headaches, nausea and unconsciousness. Get fresh air if anyone shows signs of carbon monoxide poisoning, and/or if carbon monoxide detector alarm sounds.

A poisoning victim's skin often turns cherry red. Because carbon monoxide gas (CO) is odorless, colorless and tasteless, it is unlikely to be noticed until a person is overcome.

# SECTION 1 • SAFETY

Dangerous concentrations of carbon monoxide will be present if:

- the engine exhaust systems leak;
- a nearby vessel's engine is running
- insufficient fresh air is circulating where people are present; and
- fumes move from the rear of the boat into the cockpit and cabin area.

Figure 1.3.1 gives examples of boat operating conditions that can lead to high concentrations of carbon monoxide gas.

To minimize the danger of CO accumulation when the engine is running, or using burning fuel appliances.

- Be sure to have sufficient ventilation when using canvas or window-type side curtains when underway, anchored, moored or docked.
- If a convertible or camper top is installed, operate with the forward hatch open and leave cabin door open.
- Operate all burning fuel appliances, such as charcoal, propane, LPG, CNG or alcohol cooking devices in

areas where fresh air can circulate. Do not use such devices where there is no noticeable air movement, especially in the cabin, when anchored, moored or docked.

- Do not idle engine without moving boat for more than 15 minutes at a time.
- Inspect the exhaust system regularly. (See Section 8, Required Inspection, Service and Maintenance.)

If CO poisoning is suspected, have the victim breathe fresh air deeply. If breathing stops, resuscitate. A victim often revives, then relapses because organs are damaged by lack of oxygen. Seek immediate medical attention.

## CARBON MONOXIDE MONITOR

Your boat may have a carbon monoxide (CO) monitor mounted in the cabin. The CO monitor is an electronic instrument that detects CO. When there is a build-up of CO in the cabin, the monitor will alert the occupants by a flashing DANGER light and alarm.

Read and understand the CO monitor information and operating instructions. It is extremely important that you become totally familiar with your CO monitor and its functions.

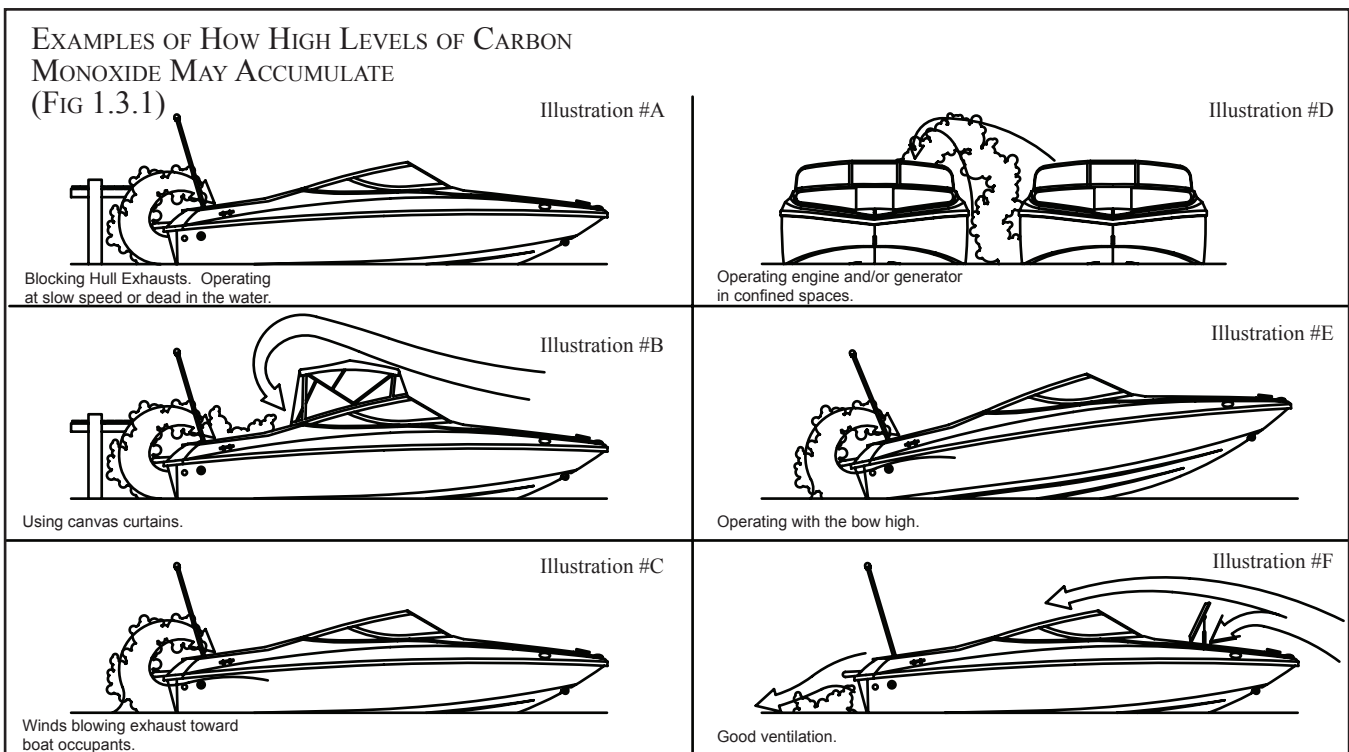

## 5. LIFESAVING EQUIPMENT

### ⚠ WARNING

Have all passengers and the operator wear a Personal Flotation Device (PFD) at all times when boating.

When someone is overboard, it can be too late to have them put on a PFD.

Even strong swimmers can tire quickly in the water and drown due to exhaustion, hypothermia, or both. The buoyancy provided by a personal flotation device (PFD) will allow the person who has fallen overboard to remain afloat with far less effort and heat loss, extending survival time necessary to find and retrieve them.

Boat operators are required to carry one wearable personal flotation device (Type I, II, III or V) for every person on board. Boats must also have at least one throwable device (Type IV).

The law requires that PFDs must be readily accessible, if not worn. "Readily accessible" means removed from storage bags and unbuckled. But, children and non-swimmers must wear PFDs at all times when aboard. It is common sense to have everyone on board wearing PFDs. A throwable device must also be right at hand and ready to toss.

PFD Classifications:

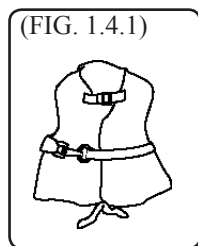

Off-Shore Life Jacket (Type I) – most buoyant, it is designed to turn an unconscious person face up; used in all types of waters where rescue may be slow, particularly in cold or rough conditions.

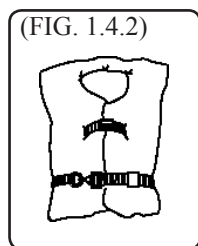

Near-Shore Life Vest (Type II) – "keyhole" vest with flotation-filled head and neck support is also designed to turn a person face up, but the turning action is not as pronounced; used in calm, inland waters or where quick rescue is likely.

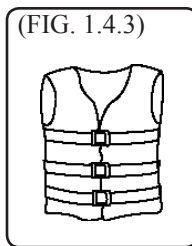

Flotation Aid (Type III) – vest is designed so conscious wearers can turn face up; often designed for comfort while engaged in sports such as skiing.

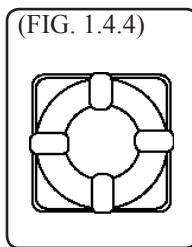

Throwable Devices (Type IV) – horseshoe buoys, ring buoys and buoyant cushions are designed to be grasped, not worn.

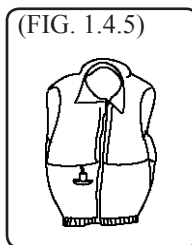

Special-Use Devices (Type V) – sailboat harnesses, white-water vests, float coats, and hybrid vests which have minimum inherent buoyancy and an inflatable chamber.

Before purchasing PFDs, ensure that there is an attached tag indicating they are approved by the U.S. Coast Guard or by your national boating law enforcement agency.

**Children and non-swimmers must wear PFDs at all times when aboard.** All passengers and crew should wear them. A loose PFD is often useless in an emergency.

The operator is responsible for instruction everyone aboard on the location and use of PFDs.

Size PFDs for the wearer. Children require special attention in the use of PFDs.

Test PFD buoyancy at least once a year.

---

# SECTION 1 • SAFETY

---

## 6. ADDITIONAL RECOMMENDED EQUIPMENT FOR SAFE OPERATION

In addition to legally mandated equipment, the following items are necessary for safe boating especially if your boat is out of sight of land.

- First aid kit
- Visual distress signals for day and night use (required in some areas; consult local regulations)
- Charts of your intended cruising area
- Compass
- GPS or Loran position locating devices
- Marine VHF radio with weather channels
- Emergency position-indicating radio beacon (EPIRB)
- Manual bilge pump
- Moisture repellent
- Anchor, chain and line (The anchor must be properly sized for your boat. Ask your dealer or marine supply store for recommendations.)
- Mooring lines
- Fenders
- Boat hook
- Waterproof flashlight(s)
- Extra batteries for flashlights and portable electronic devices
- High power spotlight, if you intend to boat at night
- Spare keys
- Instruction manuals for engine and accessories
- Lubricating oil
- Tool kit:
  - Assorted screwdrivers (Phillips and flat blade)

Pliers (regular, vise-grip, and tongue & groove)

Wrenches (box, open-end, allen, adjustable)

Socket set (metric or U.S. standard as appropriate)

Electrical tape and duct tape

Hammer

Utility Knife

- Spare parts kit (spark plugs, fuses, hose clamps and ask your dealer to recommend other parts)
- Extra propeller

## 7. IMPAIRED OPERATION

Drugs and/or alcohol will prevent you from operating your boat safely. This single factor is involved in more marine accidents and deaths than any other. The detrimental effects of alcohol and drugs are increased by the wind, waves and sun, quickly impairing your ability to react properly and promptly in an emergency.

### WARNING

**Drugs and/or alcohol impair the operator's ability to control the boat safely.**

**Death or serious injury can result from improper boat operation.**

## 8. LOAD CAPACITY

The certification plate (see Figure 1.6.1 & 1.6.2), located on the dash indicates maximum weight and number of persons your boat can handle under calm sea conditions. **Do not exceed the load capacities stated.** The number of people on board must be reduced if you go out in poor weather and rough water.

The information present on the certification plate does not relieve the operator from responsibility. Use common sense and sound judgement when placing equipment and/or passengers in your boat.

- Do not load to capacity in poor weather or rough water.





# SECTION 1 • SAFETY

In addition:

- Stability may be substantially reduced if equipment is added above the deck.
- Stability is substantially reduced by loose fluids or weight within the hull. Keep bilge area as dry as possible.

## WARNING

**Distribute passengers and gear as uniformly as possible from front to rear and left to right.**

**The manufacturer's load rating is the maximum allowed under calm conditions.**

**Reduce boat loading if weather, water or other conditions are adverse.**

## 11. MAINTAIN CONTROL

On the water there are no marked traffic lanes, no traffic signs or lights, and boats have no turn signals. The boat operator must keep her or his attention focused not only on what's ahead but what's on the left, right and behind the boat.

Observe the safety rules listed below:

## WARNING

**Death or serious injury can result if you fail to observe these safety rules:**

- **Anyone who controls the boat must have taken a boating safety course and have been trained in the proper operation of the boat.**
- **Always operate the boat at speeds that will not put people or property in danger.**
- **Be constantly aware of conditions in all directions when underway and before turning.**
- **Reduce speed, use a lookout to identify possible hazards or difficulties, and turn on navigation lights when:**
  - **visibility is impaired;**
  - **in rough water; and**
  - **in congested waterways.**

**•Watch your wake. It can capsize a small boat or damage moored boats or other property. You are responsible for damage caused by your wake.**

The operator must always be alert to approaching boats (from the rear, right and left sides, as well as those ahead). In addition, the operator must be on the lookout for people in the water, partially submerged debris, and other navigational hazards such as rocks, sand bars, and dangerous currents, to name a few.

Your passengers are relying on you to operate and maneuver the boat safely so that they are not in danger of going overboard. If you turn too quickly, increase or decrease speed abruptly, your passengers are at risk of being thrown overboard or thrown about the boat.

When visibility becomes impaired because of weather, time of day or high bow angle you must slow down so that you have sufficient time to react if an emergency occurs. Nearby boats face similar risks in avoiding a collision with you.

## GENERAL CONSIDERATIONS

- Know how your boat handles under different conditions. Recognize your limitations and the boat's limitations. Modify speed in keeping with weather, sea and traffic conditions.
- Instruct passengers on the fundamentals of operating your boat in case you are unable to do so.
- You are responsible for passengers' actions. If they place themselves or the boat in danger immediately correct them.

## 12. WEATHER

There are four design categories of boats based upon their ability to withstand wind and sea or water conditions:

- A. Ocean**  
Wind speed: above 40 knots (46 mph)  
Wave height: above 4 meters (13 feet)  
Boat may be used for extended ocean voyages.
- B. Offshore**  
Maximum wind speed: 40 knots (46 mph)  
Maximum wave height: 4 meters (13 feet)  
Boat can be used offshore, but not for extended ocean voyages.
- C. Inshore**  
Maximum wind speed: 27 knots (31 mph)  
Maximum wave height: 2 meters (6.5 feet)  
Boat use is limited to coastal waters, large bays, estuaries, lakes and rivers.

# SECTION 1 • SAFETY

## D. Sheltered waters

Maximum speed: 15 knots (18 mph)

Maximum wave height: 0.5 meters (1.5 feet)

Boat use is limited to small lakes, rivers and canals.

Your H2X boat is Design Category C.

The wind speed and wave height specified as the upper limit for your category of boat does not mean that you or your passengers can survive if your boat is exposed to these conditions. It is only the most experienced operators and crew that may be able to operate a boat safely under these conditions. You must always be aware of weather conditions and head for port or protected waters in sufficient time to avoid being caught in high winds and rough water. Do not take chances!

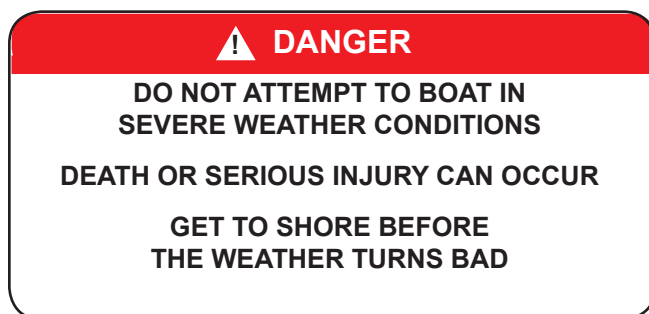

Getting caught in severe weather is hazardous. Bad weather and/or rough sea or water conditions can cause an unsafe situation. Consult local weather information, or listen to the NOAA weather reports for the latest weather conditions or any impending deterioration of the weather before setting out and while underway. The following are a few basic weather-related rules:

- Check the weather forecast and the water conditions before leaving and while underway.
- A sudden change in wind direction or speed or an increase in wave height indicates deteriorating weather.
- Have everyone wear a personal flotation device.
- If a storm approaches, immediately seek a safe harbor.
- If a storm hits, have everyone sit in the cabin or on the cockpit deck in the boat. Head the bow into the wind with enough power to maintain slow headway.
- If you encounter fog, determine your position, set a safe course, slow down and alert other boats of your presence with a sound signal.

- If a lightning storm approaches, the safest action is to dock and disembark. If you cannot return to shore, have passengers go inside the cabin and remain there until the storm passes.
- Lightning seeks a ground when it strikes. The best protection is a properly grounded lightning rod placed high enough over the deck to provide a protective umbrella over the hull. Depending upon the likelihood of your being in a lightning storm, consult your dealer for installation of a lightning rod. If caught in a storm, stay clear of the lightning rod, all attached wiring, and all metal parts of the boat.
- Stay out of the water during a lightning storm. If caught swimming during a storm, get back into the boat and remain there until the storm passes.

## 13. CHART YOUR COURSE

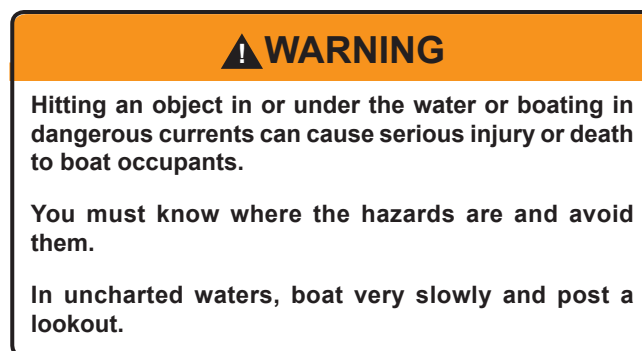

To avoid boating in unsafe areas where there are underwater obstructions, shallow water, unnavigable conditions such as dangerous currents, and others, **you must chart a course**. This means having and using the National Oceanic and Atmospheric Administration (NOAA) charts for coastal waters, observing and understanding all navigational aids, using the knowledge and guidance of experienced boaters, and being aware of the tide times where appropriate.

If you are in an unfamiliar area without knowledge of the hazards, proceed very slowly and have someone watch for hazards.

**Let others know where you're going.** A float plan describes your intended cruising course and itinerary, boat description, and your expected time and date of return. Give the float plan to a friend or relative, so they can give the information to a national boat agency, like the U.S. Coast Guard, in the event you fail to return.

# SECTION 1 • SAFETY

## ⚠ WARNING

Shut engine off if an object is struck or if you run aground.

Check for hull leaks and drive line damage, before restarting engine.

Use hand pump if bilge pumps don't remove water.

Boat very slowly, if you must proceed with a damaged drive line.

## 14. WATER SPORTS

## ⚠ DANGER

Your boat's propeller can kill or injure persons in the water.

Always stay away from areas designated for swimming or diving. Unless you are towing a skier, stay away from water ski areas. Recognize markers used for such areas.

When engine is running, close and lock transom door and do not permit anyone to use boarding ladder and swim platform.

### A. SWIMMING

- Do not permit anyone to swim from a moving boat, or a boat with an engine running.
- Many localities prohibit swimming from boats except in designated areas.
- Make sure boat's engine is turned off and the stern drive is fully down before allowing people to swim anywhere near your boat. Shut the engine OFF and remove the key from the ignition switch so that nobody will accidentally start the engine while swimmers are nearby.
- Turn off engine when taking swimmers or skiers aboard or when they are entering the water. Never permit use of the transom swim platform while engine is running.
- Slow down and look for swimmers or skiers when cruising in an area where there might be persons in the water.

### B. SKIING

## ⚠ WARNING

Skiers must wear an approved PFD.

- Anyone who water skis must know how to swim.
- Never drive the boat directly behind a water skier. At 22 knots (25 m.p.h.), it takes only 5 seconds to overtake a fallen skier who was 60 meters (200 feet) in front.
- Keep a downed skier in sight and on the operator's side of the boat when approaching the skier. Never back up to anyone in the water.
- Learn the signals to communicate with a skier. The skier is to control the boat through hand signals. (See Figure 1.9.1)

SKIING SIGNALS (FIG. 1.9.1)



**Turn** - Arm raised, circle with index finger extended.

**Skier in Water** - Extend one ski vertically out of water.

**Back to Dock** - Pat top of head.

**Cut Motor** - Draw finger across throat.

**Slow Down** - Thumb pointed down or palm down, move hand up and down.

# SECTION 1 • SAFETY

**Faster** - Thumb pointed up or palm up, move hand up and down.

**Speed OK** - Raise arm and form a circle with thumb and index finger.

**Stop** - Raise arm with palm vertical and facing forward.

**Turn Right** - Extend right arm out from body to the right.

**Turn Left** - Extend left arm out from body to the left.

**OK After a Fall** - Clasp hands together overhead.

## ⚠ WARNING

If the skier suddenly releases the tow rope, it can backlash into the cockpit. Spotters who are watching the skier must be made aware of this fact and be prepared to deflect the rope by hand to avoid injury.

## C. DIVING

Recognize and respect diving flags. (See Figure 1.10.1) Keep at least 30 meters (100 feet) away.

**Sport Divers Flag** – Red flag with diagonal white stripe marks a diver in the water.

**Code Alpha Flag** – Blue and white pennant designates boat being used in dive operations

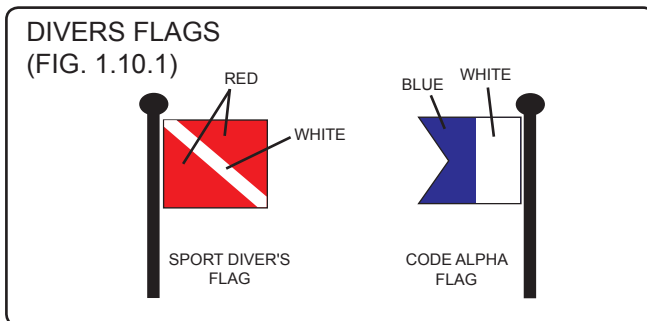

## IN GENERAL

When engaged in water sports, be safe and courteous to others sharing the water:

- Be considerate to fishermen.

- Do not water ski in congested areas.
- Keep the boat and skier away from navigation markers.
- Stay well clear of other boats and skiers.

## 15. EMERGENCY SITUATIONS

Prevention is the safest approach. We hope that you are never involved in an emergency situation.

If you are involved in an emergency situation, it is imperative that you know how to react, in order to protect the lives in your care.

### ASSISTING OTHER BOATERS

All boaters have a legal obligation to help other boaters who are in distress, as long as rendering assistance does not endanger you, your passengers or your boat.

## A. MEDICAL EMERGENCY

You may be far from professional medical help when you are boating. At least two people on board your boat should be CPR certified, and should have taken a first aid course. Equip your boat with a first aid kit.

## B. WATER RESCUE

A person who has fallen overboard will die from hypothermia in water temperatures below 70°F if not rescued quickly. Water rescue consist of three steps: returning to the victim, making contact with the victim, and getting the victim back on board.

### Returning to the Victim

- Immediately make everyone aware of the incident and keep the victim in sight.
- Slow the boat and keep pointing toward the person overboard. At night, direct the best available light source at the person.
- Throw a life preserver, even if the person is wearing a PFD. It will serve as another marker.

### Making Contact

- Slow the boat and circle toward the victim.

---

# SECTION 1 • SAFETY

---

- Try to approach heading into the wind or into the waves.
- Keep the victim on the right (starboard) side so the boat operator has the victim constantly in sight.
- When almost alongside, stop the engine in gear to prevent propeller "windmilling."

## Getting Back Aboard

- Try to reach the victim with a pole, or by throwing a life preserver. Do not swim to rescue the victim, except as a last resort.
- Assist the person in boarding the boat. The person should normally be brought in over the stern.
- If the person is injured or cannot get into the boat, a rescuer should put on a PFD with a safety line attached to the boat and enter the water to assist the victim.
- Handle the victim with care. Spinal injuries may have occurred.

## C. FIRE

Fire is a serious boating hazard. Boats can burn quickly. Do not remain on board and fight a fire for more than a few minutes. If the fire cannot be extinguished within a few minutes, abandon the boat.

Have fire extinguishers handy. A small fire can be extinguished quickly with the right size and type of fire extinguisher.

- Extinguish smoking materials, shut off blowers, stoves, engines and generators.
- Throw burning materials overboard, if possible.
- If the fire is accessible, empty the contents of fire extinguishers at the base of the flames.
- If the fire is in the engine compartment and you have an automatic extinguisher that activates, wait 15 minutes before opening the compartment. Have a portable extinguisher ready in case the fire flares up.
- Signal for help.
- Grab distress signals and survival gear. Put on PFDs. Prepare to abandon ship.

## D. FLOODING, SWAMPING AND CAPSIZING

In the event of flooding, swamping or capsizing:

- Try to shut off engines, generators and blowers before leaving the boat.
- Have everyone put on Personal Flotation Devices (PFDs).
- Account for all who were on board.
- If the boat is floating stay with the boat. Hang on, or climb on the boat and signal for help.
- Only as a last resort should you attempt to swim to shore - it is further away than it looks and you can tire and drown.

## E. COLLISIONS AND LEAKING

In the event of collisions and leaking:

- Slow down or stop to reduce water intake, unless maintaining speed will keep the hole above water.
- Switch on bilge pump.
- Operate manual bilge pump, if the powered bilge pump can't handle the water flow.
- Account for everyone on board and check for injuries.
- Have everyone put on PFDs.
- Stay with the boat.
- Signal for help.
- If a leak patch is attempted, it should be done from the outside.
- In the event of a collision, you are required to file an accident report. Contact a state enforcement agency or the nearest Coast Guard office. If you are boating outside of U.S. waters, consult the nation you are visiting for accident reporting requirements.

---

# SECTION 1 • SAFETY

---

## F. GROUNDING

In the event of running aground:

- Check for leaks. If water is coming in, stop the intake of water before attempting to get the boat free.
- Inspect for damage to the hull, propulsion and steering systems.
- Determine if the tide, wind and current will drive the boat harder aground or will help to free it.
- Determine the water depth all around the boat, and the type of bottom (sand, mud, rocks, etc.). If it can be done without exposing persons to a risk of injury, the boat should be moved away from hard obstructions, and toward open water with soft ground.
- Do not attempt to have your boat towed by other than a trained and competent service, such as the Coast Guard or a salvage company. Recreational craft are not designed to tow other recreational craft.

## G. PROPULSION, CONTROL OR STEERING FAILURE

If the drive train fails, or the controls or steering do not respond properly or at all:

- Shut off engine.
- Put out the anchor to prevent drifting.
- Determine whether or not you can repair the problem yourself. See the proper manuals for assistance in troubleshooting the engine, steering and engine controls.
- If you are not sure you can fix the problem, or if conditions are adverse, signal for help.

## 16. SAFETY HOTLINES

**The safety information in the preceding pages gives only the general areas of concern for boating safety. It is not intended to be, nor can it be, exhaustive. You must take a boating safety course, and get hands-on instruction in the proper and safe operation of your boat from experienced persons before cruising.**

The U.S. Coast Guard offers many pamphlets on safety and other information not covered in this manual. Contact your local Coast Guard unit or call the toll-free safety hotlines below for information.

- U.S. Coast Guard 1-800-368-5647
- Canadian Coast Guard 1-800-267-6687

It is recommended that these and other important numbers be stored in your cell phone for quick reference.

**In other countries, ask your marine dealer for information on how to contact the national boating law enforcement agency.**

## 17. INTERNATIONAL REQUIREMENTS

This vessel and its systems have been constructed in accordance with standards and specifications in effect at the time of manufacture as published by the various regulatory authorities listed below.

1. Ministere De La Mer – France
2. Registro Italiano Navale – Italy
3. Det Norske Veritas – Norway
4. Securite des Nauires – Canada
5. J.C.I. (Japan Craft Inspection) – Japan
6. N.K.K. (Nippon Kaiji Kyokai) – Japan
7. B.S.I. (British Standards Institute) – England
8. Ministerio Obras Publicas Y Transporters – Spain
9. EC Recreational Craft Directive – European Community

Further information concerning these requirements may be obtained from Baja® Marine Customer Service: 1-865-971-6270.

# SECTION 1 • SAFETY

## 18. ENVIRONMENTAL CONSIDERATIONS

The following warning is offered for boats sold in the State of California in accordance with California Health & Safety Code §§ 25249.5-.13:

### WARNING

A wide variety of components used on this vessel contain or emit chemicals known to the State of California to cause cancer and birth defects and other reproductive harm.

#### EXAMPLES INCLUDE:

- Engine and generator exhaust
- Engine and generator fuel, and other liquids such as coolants and oil, especially used motor oil
- Cooking fuels
- Cleaners, paints, and substances used for vessel repair
- Waste materials that result from wear of vessel components
- Lead from battery terminals and from other sources such as ballast or fishing sinkers

#### TO AVOID HARM:

- Keep away from engine, generator, and cooking fuel exhaust fumes.
- Wash areas thoroughly with soap and water after handling the substances above.

### A. FUEL AND OIL SPILLAGE

Regulations prohibit discharging fuel or oily waste in navigable waters. Discharge is defined as any action which causes a film, sheen or discoloration on the water surface, or causes a sludge or emulsion beneath the water surface. A common violation is bilge discharge. Use rags or sponges to soak up fuel or oily waste, then dispose of it properly ashore. If there is much fuel or oil in the bilge, contact a knowledgeable marine service to remove it. Never pump contaminated bilge overboard. Help protect your waters.

Fill tank(s) less than rated capacity. Allow for fuel expansion.

### B. WASTE DISPOSAL

- Many areas prohibit overboard sewer discharge. Close and disable flow-through waste systems to prevent discharge in such areas.
- Bag all refuse until it can be disposed of ashore. Regulations prohibit disposal of plastic anywhere in the marine environment and restrict other garbage disposal within specified distances from shore.

### NOTICE

It is illegal for any vessel to dump plastic trash anywhere in the ocean or navigable waters of the United States.

### C. EXCESSIVE NOISE

Many areas regulate noise limits. Even if there are no laws, courtesy demands that boats operate quietly.

### D. WAKE/WASH

### WARNING

**SPEED HAZARD-** Watch your wake. It might capsize a small craft. You are responsible for damage caused by your wake.

Power boat wakes can endanger people and vessels. Each power boat operator is responsible for injury or damage caused by the boat's wake. Be especially careful in confined areas such as channels or marinas. Observe "no wake" warnings.

### CAUTION

Reduce speed in congested waterway.

Be alert for No Wake Markers.

---

# SECTION 1 • SAFETY

---

## 19. NAUTICAL TERMS

**Abeam** - object 90 degrees ( $\perp$ ) to center line on either side of boat.

**Abaft** - a point on a boat that is aft of another.

**Aft** - toward the rear or stern of the boat.

**Beam** - the maximum width of a boat.

**Bilge** - the lowest part of the hull on the inside where fluids collect.

**Bow** - the forward part of a boat.

**Bow Eye** - bolt with looped head mounted on extreme forward part of bow, used for towing or tying up boat.

**Bulkhead** - vertical partition in a boat

**Chine** - meeting juncture of side and bottom of boat.

**Chock** - deck fitting, used as a guide for mooring or anchor lines. Also, a wedge to stop wheels from rolling.

**Cleat** - deck fitting with arms or horns to which lines are tied or made fast.

**Cockpit** - the open space from which a boat is operated.

**Deck** - upper structure which covers the hull between gunwales.

**Downwind** - in the direction the wind is blowing toward

**Draft** - depth of water required to float boat and its propulsion system.

**Fathom** - six feet.

**Fenders** - rope or plastic pieces hung over the side to protect the hull from chafing against a dock or another boat.

**Freeboard** - height of exposed hull from water line to deck.

**Ground tackle** - general term referring to anchors, anchor lines, etc.

**Gunwale** (pronounced gun'l) - where the hull and deck come together; the "sides" of the boat in the cockpit area.

**Hatch** - an opening in the deck to provide access below.

**Head** - toilet or toilet area in a boat.

**Headroom** - vertical distance between the deck and cabin or canopy top.

**Helm** - steering and controls console.

**Hull** - the lower part of a boat beneath the deck and cockpit that provides buoyancy to float the weight of the craft and its load.

**Keel** - the major longitudinal member of a hull; the lowest external portion of a boat.

**Knot** - unit of speed in nautical miles per hour.

**Lee** - the side that is sheltered from the wind.

**PFD** - Personal Flotation Device; life jacket or preserver.

**Port** - term designating left side of the boat when facing forward.

**Rudder** - Movable fixture at the stern used for steering.

**Scupper** - hole permitting water to drain overboard from deck or cockpit.

**Sheer** - curve or sweep of the deck as viewed from the side.

**Snub** - to check or tighten a line suddenly.

**Starboard** - term designating right side of the boat.

**Stern** - the rear (aft) end of a boat.

**Stern drive** - outboard unit of an inboard/outboard (I/O) engine installation.

**Stringer** - longitudinal members fastened inside the hull for additional structural strength.

**Transom** - the rear part of the boat across the back, to which the drive unit and swim platform are attached.

**Upwind** - in the direction the wind is blowing from.

**Wake** - disturbed water that a boat leaves behind as a result of forward motion.

**Windward** - toward the direction from which the wind is blowing.



# SECTION 1 • SAFETY

## 20. KEY TO SYMBOLS ON CONTROLS & PRINTS

These symbols may be found on your controls and gauges and/or used in this owner's manual. This page is to help you understand what the symbols mean.

 PROPULSION SYSTEM TRIM	 PROPULSION SYSTEM TRIM BOW UP	 PROPULSION SYSTEM TRIM BOW DOWN	 TRIM TAB TRIMMING OPERATION	 SINGLE LEVER CONTROL (THROTTLE & SHIFT)	 CONTROL LEVER OPERAT- ING DIRECTION
 LIFT POINT OR PROPER LOCATION OF SLING	 ENGINE START	 ENGINE STOP	 FUEL LEVEL	 FUEL FILTER	 ENGINE
 ENGINE COOLANT	 ENGINE (COOLANT) WATER JACKET TEMPERATURE	 ENGINE OIL PRESSURE	 WARNING ELECTRICAL HAZARD	 FIRE RISK	 NO OPEN FLAME NO SMOKING
 ROTARY CONTROL (QUANTITY INCREASES WITH WIDTH OF SYMBOL)	 FRESH WATER BASED COOLANT	 LEADED FUEL	 UNLEADED FUEL	 OIL	 WASTE WATER/SEWAGE
 FUEL, GENERAL	 DIESEL FUEL	 LIFT POINT	 ELAPSED TIME	 ENGINE ROTATIONAL SPEED	 BILGE PUMP
 BILGE BLOWER	 PROPELLER	 INTERIOR LIGHT	 RUNNING LIGHTS UNDER POWER	 ANCHOR LIGHT	 WINDSHIELD WIPER
 WINDSHIELD WIPER	 WINDSHIELD WIPER AND WASHER	 COMPASS	 ANCHOR	 HORN	 BATTERY

---

# SECTION 1 • SAFETY

---

THIS PAGE INTENTIONALLY LEFT BLANK

# 21. WARNING LABEL LOCATIONS

WARNING LABEL LOCATIONS  
(Fig 1.17.1)

**WARNING**

LEAKING FUEL IS A FIRE AND EXPLOSION HAZARD. INSPECT SYSTEM REGULARLY. EXAMINE FUEL TANKS FOR LEAKS OR CORROSION AT LEAST ANNUALLY.

MRP #952632 SR-151

**WARNING**

• IN CASE OF FIRE DO NOT OPEN ENGINE BOX OR COMPARTMENT.

• SHUT DOWN ENGINES, GENERATOR OR BLOWERS.

• CONTINUOUSLY DISCHARGE ENTIRE CONTENTS OF HALON OR CO<sub>2</sub> PORTABLE FIRE EXTINGUISHER THROUGH PORT IMMEDIATELY.

**WARNING**

Carbon monoxide (CO) can cause brain damage or death. Carbon monoxide can be present in the exhaust.

Signs of carbon monoxide poisoning include nausea, headache, dizziness, drowsiness, and lack of consciousness.

Get fresh air if anyone shows signs of carbon monoxide poisoning. Get fresh air if carbon monoxide detector alarm sounds. Carbon monoxide detector must be functioning at all times.



**WARNING**

A wide variety of components used on this vessel contain or emit chemicals known to the State of California to cause cancer and birth defects and other reproductive harm.

EXAMPLES INCLUDE:

- Engine and generator exhaust
- Engine and generator fuel, and other liquids such as coolants and oil, especially used motor oil.
- Cooking fuels.
- Cleaners, paints, and substances used for vessel repair.
- Waste materials that result from wear of vessel components.
- Lead from battery terminals and from other sources such as ballast or fishing sinkers.

TO AVOID HARM:

- Keep away from engine, generator, and cooking fuel exhaust fumes.
- Wash areas thoroughly with soap and water after handling the substances above.

California Health & Safety Code §§ 25249.5-.13

*California Residents Only*

The above warning is attached to the steering wheel prior to delivery of any boats sold in the state of California in accordance with California Health and Safety Code §§ 25249.5-.13

**DANGER**

TO AVOID RISK OF SERIOUS INJURY OR DEATH SHUT OFF ENGINE WHEN NEAR SWIMMERS OR PRIOR TO USING SWIM PLATFORM AND BOARDING LADDER.

**DANGER**

Carbon monoxide (CO) can cause brain damage or death.

Engine and generator exhaust contains odorless and colorless carbon monoxide gas.

Carbon monoxide will be around the back of the boat when engines or generators are running.

Move to fresh air. If you feel nausea, headache, dizziness, or drowsiness.



**WARNING**

HATCH MUST BE CLOSED AND SECURE BEFORE OPERATING THE BOAT

**DANGER**

GASOLINE VAPORS CAN EXPLODE RESULTING IN INJURY OR DEATH

Before starting engine:

- Check engine compartment bilge for gasoline or vapors
- Operate blower for four (4) minutes
- Verify blower operation

Run blower below cruising speed.

AVOID COLLISIONS - Maintain lookout as required by "Rules of the Road". Visibility can be limited by high boat trim angles, persons and gear. Such issues are considered under the control of the operator.

- The driver & passengers **MUST** remain seated any time the craft is in motion.
- An approved Personal Flotation Device (PFD) **MUST** be worn by all occupants at all times.
- The driver **MUST** use the safety lanyard at all times.
- The passengers **MUST** use the hand holds while the craft is in motion.

Use caution with skier in tow as rope may backlash into cockpit when released.

TO AVOID RISK OF INJURY OR DEATH, SHUTOFF ENGINE NEAR SWIMMERS OR PRIOR TO USING SWIM PLATFORM OR SUNPAD.

**Baja Marine Corp.**

H2X

0609

MAXIMUM

6 + = 510 kg

= 365 kw

Replaces NMMA capacity plate (above) on boats with CE international option.

	Pêches et Océans Canada Coast Guard	Pêches et Océans Canada Garde côtière	Canada
BUILDER-CONSTRUCTEUR	MODEL- MODELE		
BAJA MARINE CORPORATION AGC	H2X		
THE MANUFACTURER CERTIFIES THAT THIS PRODUCT COMPLIES WITH THE CONSTRUCTION STANDARDS FOR SMALL VESSELS.		LE FABRICANT CERTIFIE QUE CE PRODUIT EST CONFORME AUX NORMES DE CONSTRUCTION DES PETITS BATEAUX.	
NO. no POXV 1454			

U.S. COAST GUARD

MAXIMUM CAPACITIES

**6 PERSONS OR 1600 LBS.**  
1600 POUNDS, PERSONS, GEAR

THIS BOAT COMPLIES WITH U.S. COAST GUARD SAFETY STANDARDS IN EFFECT ON THE DATE OF CERTIFICATION

MANUFACTURER: BAJA MARINE, BUCYRUS, OH, 44820

MODEL: H2X

DESIGN COMPLIANCE WITH NMMA REQUIREMENTS IS VERIFIED. MANUFACTURER RESPONSIBLE FOR PRODUCT CONTROL.

**NMMA CERTIFIED**

NATIONAL MARINE MANUFACTURERS ASSOCIATION

**WARNING**

MANEUVERABILITY ABOVE 35 MPH IS LIMITED. SUDDEN TURNS MAY CAUSE LOSS OF CONTROL. READ OWNERS MANUAL!

**WARNING**

Carbon monoxide (CO) can cause brain damage or death.

Engine and generator exhaust contains odorless and colorless carbon monoxide gas.

Signs of carbon monoxide poisoning include nausea, headache, dizziness, drowsiness, and lack of consciousness.

Get fresh air if anyone shows signs of carbon monoxide poisoning.

See Owner's Manual for information regarding carbon monoxide poisoning.

THIS PAGE INTENTIONALLY LEFT BLANK

# SECTION 2 • GENERAL BOAT ARRANGEMENT

## 1. DOCKING/LIFTING/TRAILERING

### ⚠ CAUTION

Do Not use cleats for lifting.

**CLEATS:** Cleats must not be used for lifting the boat; they are intended for docking or mooring use only.

**BOW AND STERN EYES:** The bow eye must be used to haul the boat onto a trailer. The stern eyes must be used as tie down points for trailering the boat. The bow and stern eyes may be used for short term lifting of the boat such as for service. Long term lifting with the bow and stern eyes may cause stress on the fiberglass and gel coat.

For long term storage, use flat, wide belt-type slings and spreaders long enough to keep pressure from gunwales. Do not place slings where they may lift on underwater fittings.

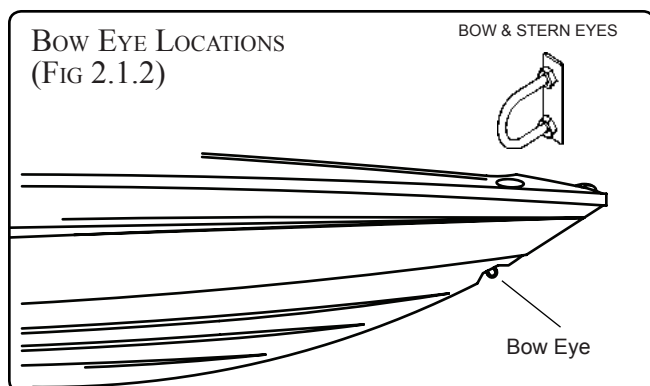
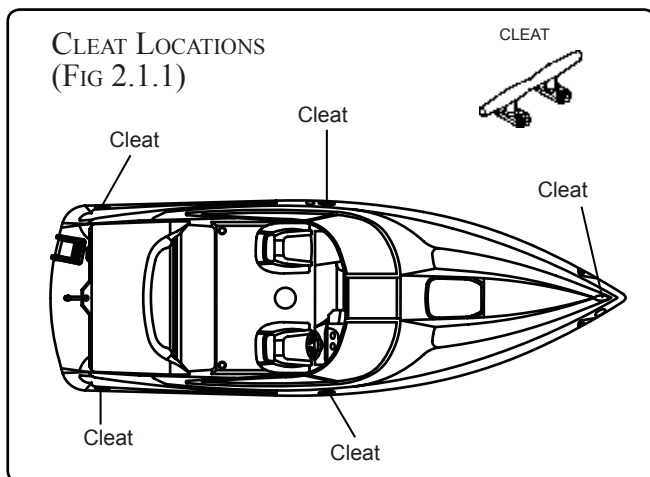

## 2. PASSENGER LOCATIONS

### ⚠ WARNING

Boat motion can be erratic.

You can fall overboard or be injured by hitting something in or on the boat.

All persons must be in cockpit area or cabin and be prepared for sudden boat movement.

Use front or bow deck area only during anchoring, mooring or emergencies.

### ⚠ WARNING

Wet decks are slippery.

You can be seriously injured if you slip and fall.

Wear slip resistant footwear secured to your feet and hold on to rails or boat structure.

1. When the boat is moving, all passengers must be on the seating provided or, if standing, holding on firmly.

While the person at the wheel must alert passengers before any sudden or erratic boat movement, such as crossing wakes, rapid turns, sudden acceleration or deceleration, etc., an emergency action may be necessary before passengers can be warned. All passengers must be prepared for rapid boat movement and be able to hold on to prevent loss of balance.

2. When persons are on the working deck area, for anchoring, mooring, or in emergencies, they must be holding on and be positioned so as to prevent falling. In bad weather and/or rough water, if it is essential to be on deck, persons should be closely tied to cleats, railing stanchions, or other securely fastened boat hardware.
3. Engines must be turned off and the stern drive fully down if the boat is near swimmers or persons are on the swim platform or the swim ladder.

# SECTION 2 • GENERAL BOAT ARRANGEMENT

## 3. BASIC BOAT DIMENSIONS AND CLEARANCES (UNITED STATES STANDARD S.A.E.)

BOAT DIMENSIONS AND CLEARANCES  
(FIG. 2.2.1)

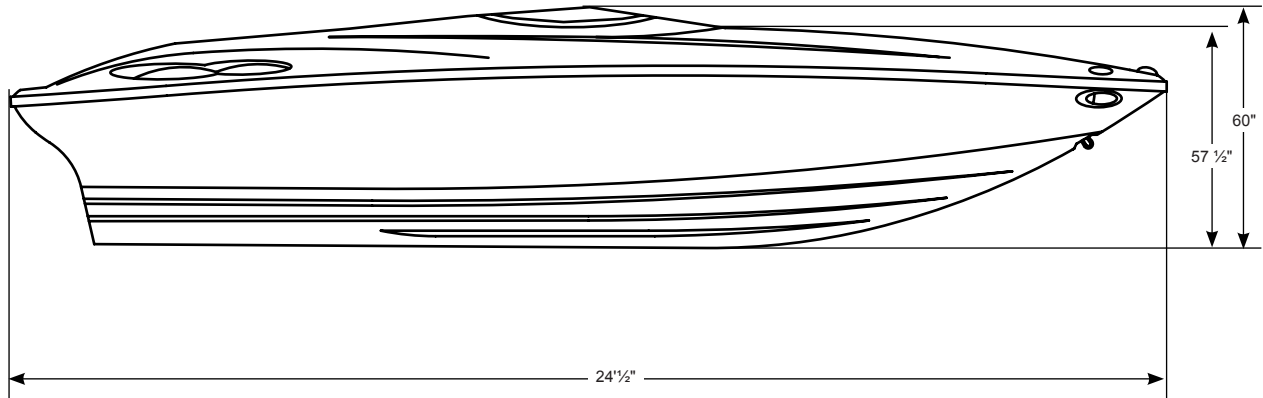

### H2X SPECIFICATIONS

Overall Length .....	24' 1/2"
Overall Length (w/ drive down).....	24' 11"
Beam (width) .....	8' 4"
Draft (stern drive down).....	35"
Draft (stern drive up in trailering position).....	20"
Dry Weight.....	3,900 pounds
Fuel Capacity.....	80 gallons

### HEIGHT DIMENSIONS

From Keel without Windshield.....	57 1/2"
Keel To Top Of Windshield.....	60"
From Waterline without Windshield.....	37 1/2"
From Waterline to Top of Windshield.....	40"

STERN DRIVE (INBOARD-OUTBOARD) ENGINE  
(FIG 2.2.2)

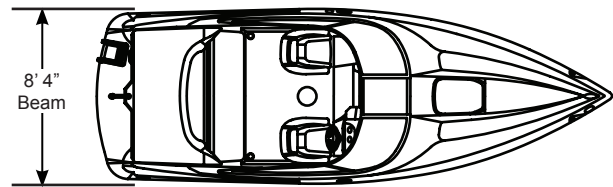
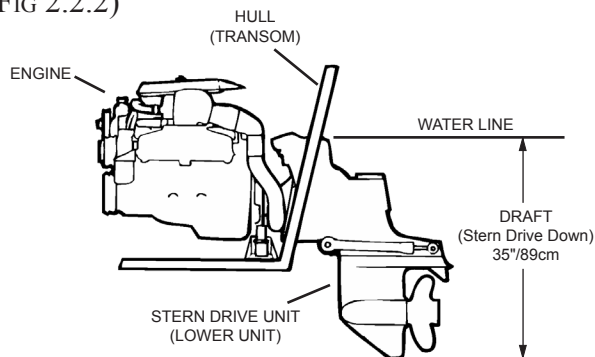

(FIG. 2.2.3)

**Specification measurements are approximate and subject to variance.**

# SECTION 2 • GENERAL BOAT ARRANGEMENT

## BASIC BOAT DIMENSIONS AND CLEARANCES (METRIC)

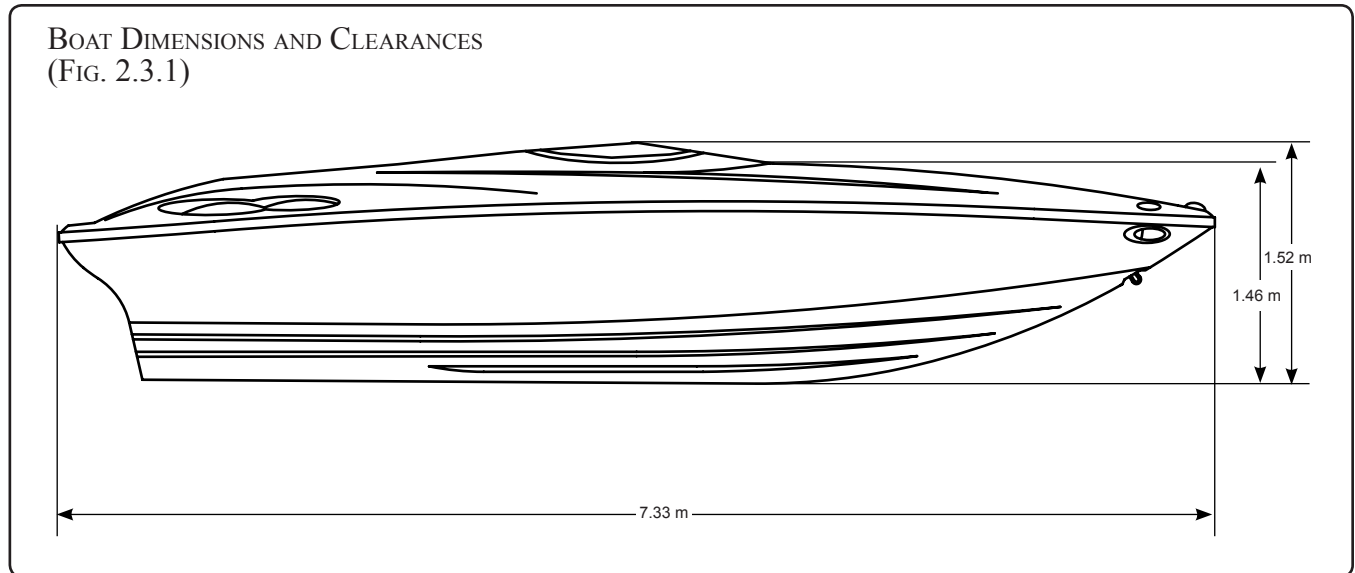

H2X SPECIFICATIONS

HEIGHT DIMENSIONS

Overall Length.....	7.33 m
Overall Length (w/ drive down).....	7.59 m
Beam (width).....	2.54 m
Draft (stern drive down).....	.89 cm
Draft (stern drive up in trailering position).....	50.8 cm
Dry Weight.....	1,769 kg
Fuel Capacity.....	302.8 liters

From Keel without Windshield.....	1.46 m
Keel To Top Of Windshield.....	1.52 m
From Waterline without Windscreen.....	.94 cm
Waterline to Top of Windshield.....	1.02 m

### 4. PROPULSION SYSTEM

Your boat is equipped with a stern drive type propulsion system also known as an inboard-outboard engine. (See Figure 2.2.2) This type of propulsion system has the engine inside the boat secured to the hull's stringers at the rear end of the hull. The stern drive unit, also called the lower unit because it hangs below the hull, is part of the propulsion system that attaches to the outside of the hull or transom. The stern drive unit pivots to steer the boat.

For engine operating instructions, see page 3.4.

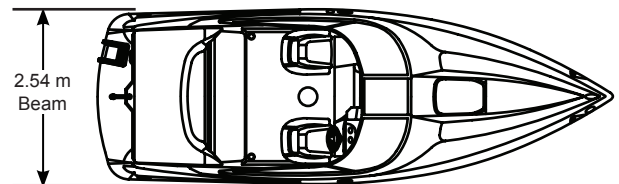

(FIG. 2.2.3)

### 5. PROPELLERS

Your Baja® has been equipped with a propeller which our tests have shown to be the best suited for general use under normal conditions and load.

**Under no circumstances use a propeller which allows the engine to operate at higher than the maximum RPM for your engine. (See the Engine Operator's Manual.)**

# SECTION 2 • GENERAL BOAT ARRANGEMENT

## 6. GENERAL DECK LAYOUT

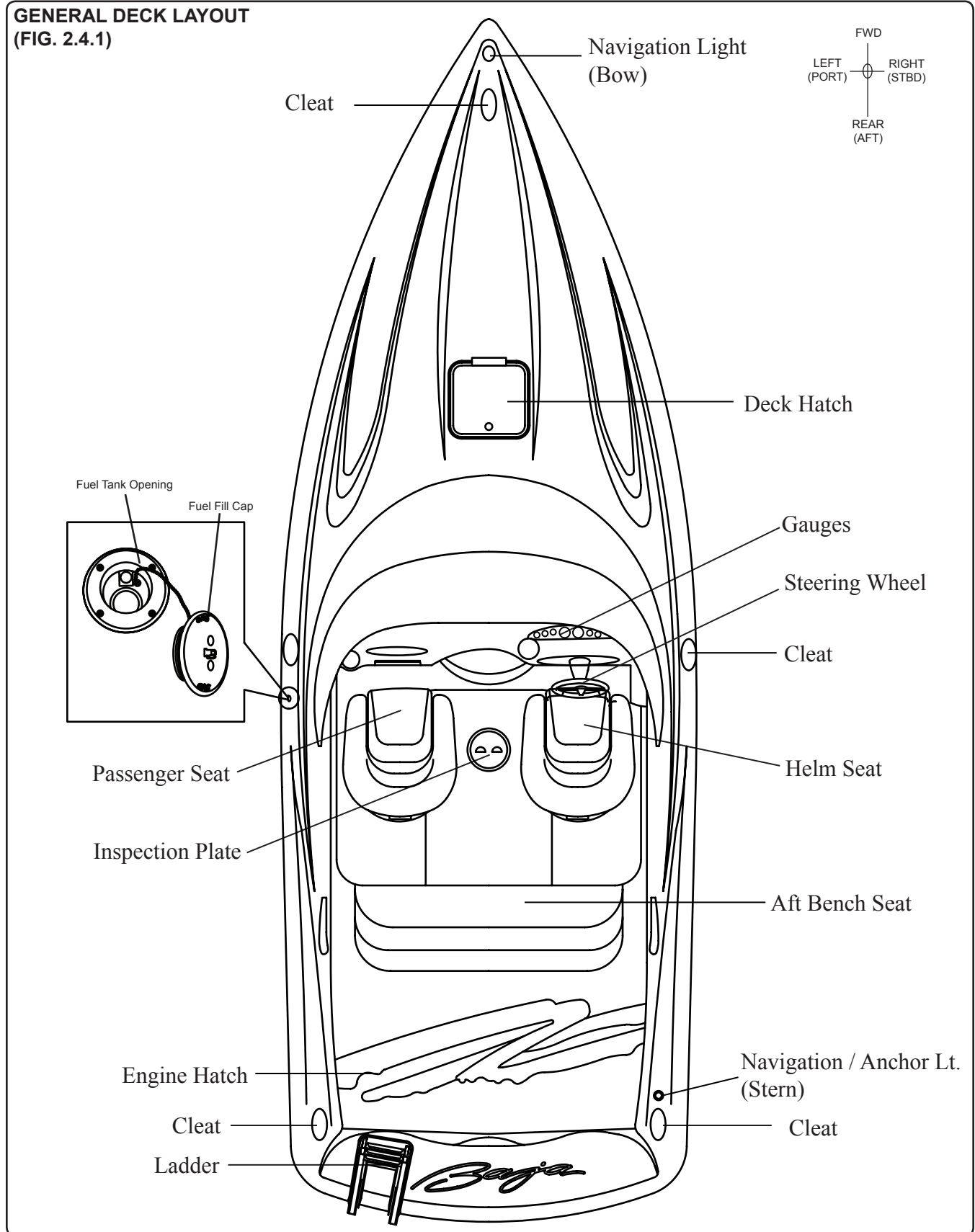



## SECTION 2 • GENERAL BOAT ARRANGEMENT

### 7. DESCRIPTION OF MAJOR CONTROLS

#### A. GEAR SHIFT AND THROTTLE CONTROL

The shift/throttle control unit for the engine is activated by individual handles. (See Figure 2.5.1) The shift handle must be in neutral position to start your engine. Moving the shift handle forward engages the forward gear. Then move the throttle arm or handle forward to increase engine speed and propeller RPM, moving the boat faster. To shift to reverse, bring the shift handle lever back to the neutral position after bringing back the throttle handle first, then move it further back to engage the reverse gear. Move the throttle handle to increase engine speed and propeller RPM, moving the boat faster in reverse.

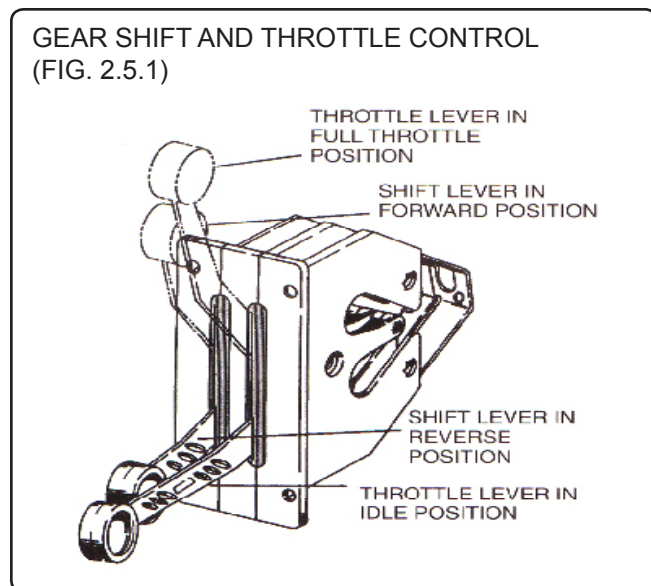

The throttle control adjusts the RPM of the engine and thus, the rotational speed of the propeller. Regulating the RPM of the engine controls the speed of the boat.

Forward motion creates forward moving water called a "following" wake. If the boat is moving forward and the shift/throttle is moved quickly from forward to reverse, the boat will stop rapidly and then move backward. The following wake continues to move forward and can rise above the transom and flood the boat.

#### **CAUTION**

Cockpit can fill with water if boat is moving forward fast enough to create a wake, and then quickly put into reverse.

Before shifting into reverse, shift to neutral, wait for the boat to stop rapidly moving forward, then shift into reverse.

Do not shift to reverse too soon. Wait for the following wake to dissipate.

#### B. POWER TRIM UNIT AND GAUGE

The Power Trim allows the operator to raise and lower the stern drive unit while underway to provide the ideal boat angle (in relation to water surface) for a given load and water condition. (See Figure 2.5.2)

Trimming UP rotates the stern drive and propeller away from the transom. Trimming DOWN rotates the stern drive and propeller closer to the transom.

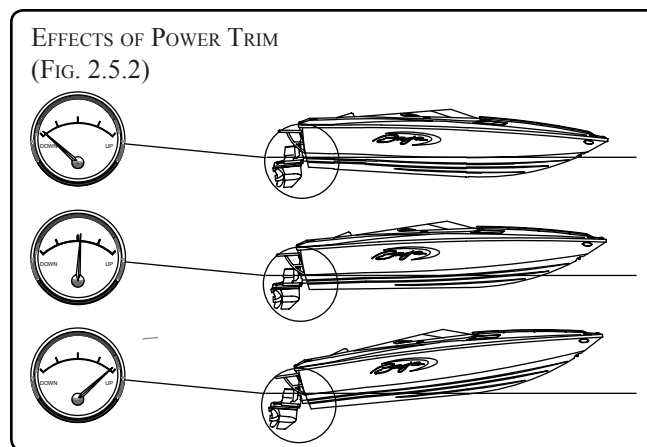

When the stern drive is trimmed DOWN, the bow of your boat is being forced down. If the trim is in the full DOWN position when accelerating from idle to plane, the boat will plane faster with less bow rise. Once on plane, the stern drive unit can be trimmed UP *slightly*. This will raise the bow of the boat slightly and increase speed. You will need to try small differences in the stern drive position to determine the trim position you prefer under various conditions.

If you raise the stern drive up too far while on plane, you could cause a loss of speed and power due to a condition called propeller "ventilation." If this happens, there will be a sudden increase in engine RPM and loss of speed. Do not let this condition exist. Immediately reduce your engine RPM and trim the outdrive DOWN slightly until engine slows down and you regain forward speed.

The trim gauge indicates the position of the stern drive relative to the transom.

REFER TO YOUR ENGINE OPERATOR'S MANUAL FOR PROPER TRIM GAUGE SETTING.

# SECTION 2 • GENERAL BOAT ARRANGEMENT

## C. TRAILER SWITCH

The trailer switch (Power Tilt) is not to be confused with the Power Trim function. The trailer switch is to be used only when the engine is off.

The trailer switch allows the drive unit to be raised for trailering, beaching and launching. To operate, press and hold the trailer switch until the drive unit reaches the end of upward travel. The mechanism that raises the lower unit will stop operating at the end of the upward travel. To bring the drive unit down into boating position, push the power trim switch down.

## D. TRIM TABS

The trim tabs (see Figure 2.6.1) are different from the stern drive unit trim control. The trim tabs are two flat plates, hinged below the water line on the transom at the rear and are raised and lowered hydraulically by using the rocker switches located at the helm station.

The trim tabs are used to adjust the sideways listing of the boat due to uneven loading, a strong cross wind or propeller torque. The twisting effect of propeller torque is especially pronounced when running the engine at high horsepower output.

To correct the listing, adjust the trim tabs to level the boat. When the boat is level, right to left, the steering effort will be the same for right and left turns.

Lower the trim tab on the listing (lower) side by pushing the top half of the rocker switch in one-half second bursts until the boat is righted.

Using both switches to lower both tabs on a side-to-side balanced boat will lower the bow, when on plane, if the rear of the boat is highly loaded. Again, use only short bursts of the rocker switches to adjust the trim.

When running at cruising speed, the trim tabs should be fully up, unless the rear is heavily loaded.

In heavy following seas or when running in an inlet, best maneuverability is obtained with a bow high attitude. To be sure the tabs are full up, push the bottom halves of the rockers for several seconds.

RUNNING ATTITUDE	LIST	Push
BOW UP	-----	Top of Both Switches
BOW UP	Port	Top of Starboard Switch
BOW UP	Starboard	Top of Port Switch
BOW DOWN	Port	Bottom of Starboard Switch
BOW DOWN	Starboard	Bottom of Port Switch

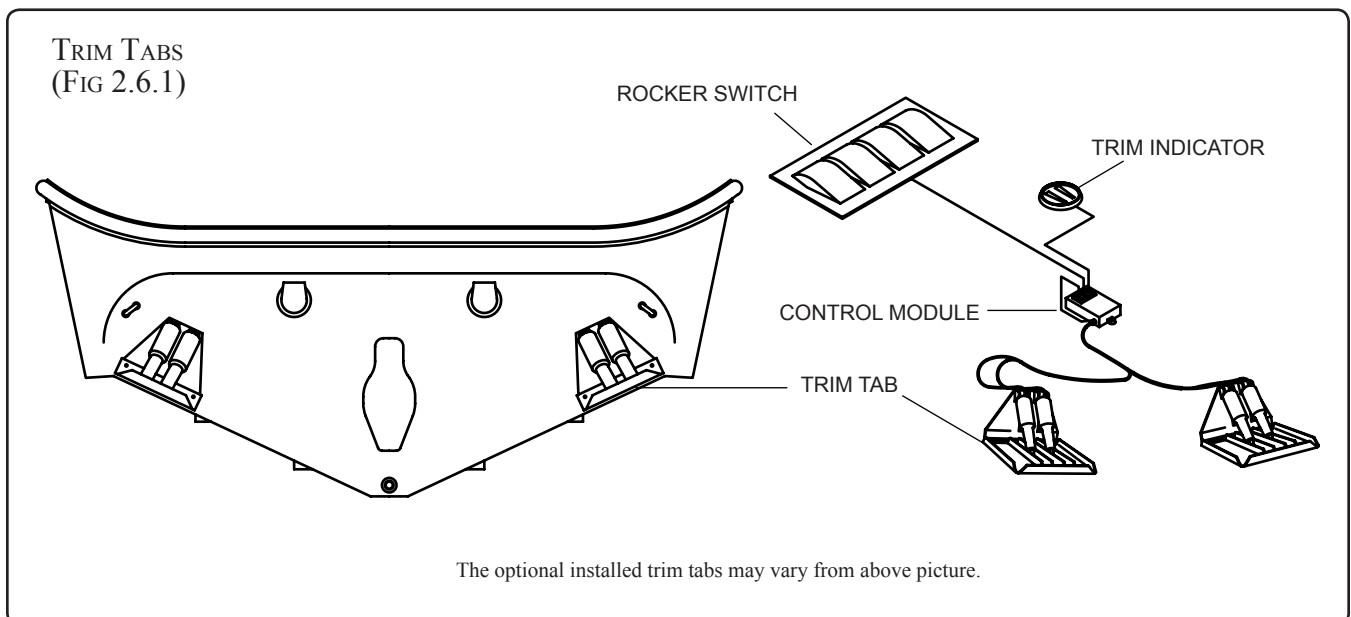

## SECTION 2 • GENERAL BOAT ARRANGEMENT

### C. IGNITION SHUTDOWN SWITCH

Figure 2.7.1 shows the ignition shutdown switch. The purpose of the switch is to shut down the engine if the operator unintentionally leaves the helm station. Situations in which this could occur are rough water, bad weather and other adverse boating conditions. In these situations, the safety of the boat and its passengers is enhanced by using the ignition shutdown switch, since the boat will stop when the operator can no longer control the boat.

However, unexpected engine shutdown may result in unintentional harm. For example, a passenger may lose balance and fall, or control could be lost during docking. No specific guidelines can be given for switch use. The ultimate decision of when to use an ignition shutdown switch rests with the operator or owner.

When the switch is used, the operator must securely clip the lanyard to their belt or clothing so that if the operator falls overboard or into the boat, the switch is activated and the engine shuts down.

To reset ignition shutdown switch after it has been activated, simply reinstall the switch clip above the shut-off switch and flip the switch to the "UP" position.

### D. ENGINE ALARM SYSTEM

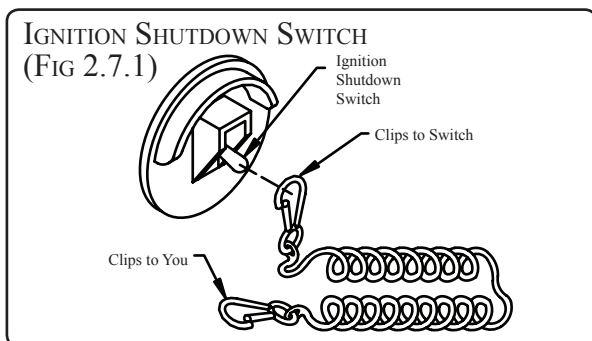

The Engine Operator's Manual will tell you if your engine is equipped with an audible alarm and how to use it.

The alarm indicates a problem with engine water temperature, oil pressure and/or stern drive oil level.

### 8. IMPORTANT GAUGES

#### ⚠ CAUTION

**Always check oil pressure and water gauges before leaving dock and while underway, even if your engine has an alarm.**

**Shut down engine immediately if gauges are not in normal ranges, or alarm sounds.**

**Do not restart engine until problems are corrected.**

### A. TACHOMETER AND HOUR METER

The tachometer (see Figure 2.7.2) indicates the revolutions per minute (RPM) of the engine (it does not indicate the speed of the boat). Your Engine Operator's Manual indicates the maximum full throttle RPM at which your engine should operate. This must not be exceeded or serious engine damage will occur. The tachometer should also be used to determine the most comfortable and economical cruising RPM.

The hour meter measures cumulative hours of operating time on the engine. Use the hour meter to keep a careful log of when to maintain the engine as well as to estimate fuel consumption. Do not leave ignition key in the "ON" position with engine off, because the hour meter will continue to run, even though the engine is not operating.

TYPICAL TACHOMETER WITH HOUR METER  
(FIG 2.7.2)

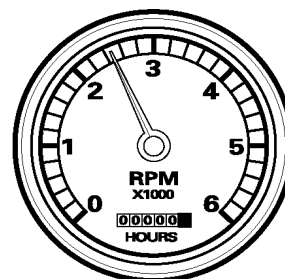

## SECTION 2 • GENERAL BOAT ARRANGEMENT

### B. OIL PRESSURE, WATER TEMPERATURE, VOLTMETER AND FUEL GAUGES

These gauges function on your boat the same way they do on your car or truck. You must continually check these gauges visually to make certain there are no engine system problems even if your boat engine has an alarm system.

### 9. NAVIGATION AND ANCHOR LIGHTS

Navigation lights **must** be on while underway from sunset to sunrise or in conditions of reduced visibility. "Underway" means the boat is not docked or at anchor. Trolling or drifting with engine off is considered "underway" and navigation lights must be used. (See Figures 2.8.1 and 2.8.2)

If you are anchored in open water, i.e. where other boats can approach yours, you must display your anchor light: a white light that can be seen from all possible directions, i.e. 360 degrees.

Read the "Federal Requirements and Safety Tips for Recreational Boats" provided in your Owner's Manual Packet..

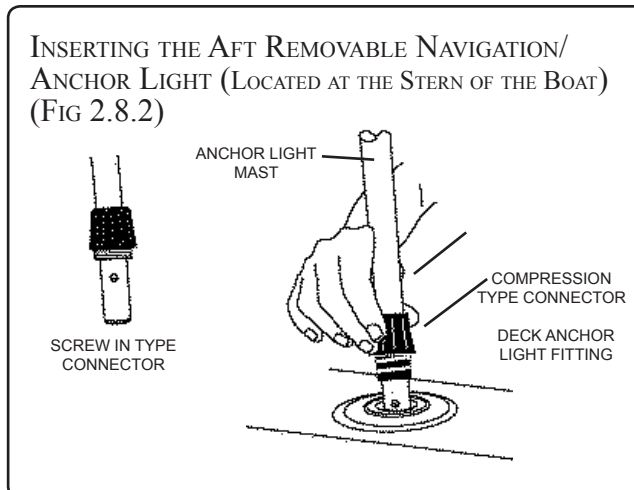

NAVIGATION AND ANCHOR LIGHTS SWITCHES  
(FIG 2.8.1)

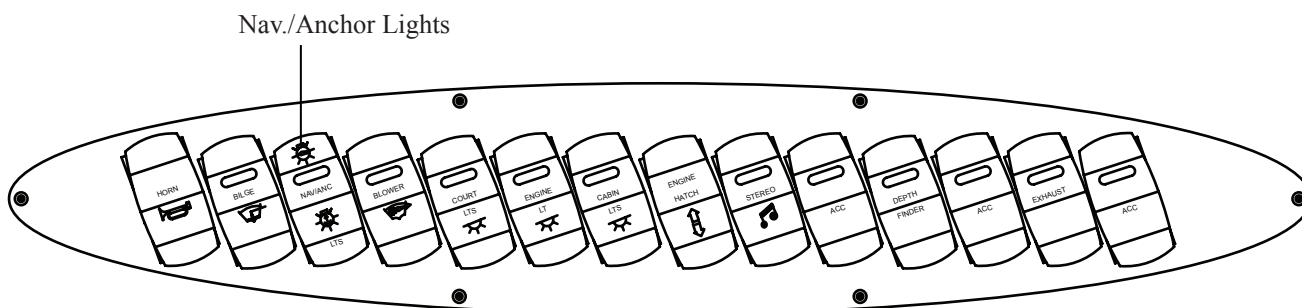

Navigation Lights (forward) - Bow & Stern Lights are on.

Anchor Light (back) - Only Stern Light is on.

---

## SECTION 3 • USING YOUR BOAT

---

### 1. PRE-LAUNCH, LAUNCH AND POST-LAUNCH CHECKLIST

Listed below are the critical items you must check and do each time you use your boat. It does not list all of the necessary maintenance and service items required to keep your boat running properly. These other items are found in Section 8.

#### BEFORE LAUNCH

- Drain plug installed
- Enough fuel for trip
- Float plan given to friend or relative
- Navigation charts for trip
- Weather forecast - safe

#### IN THE WATER, BEFORE BOARDING PASSENGERS OR STARTING ENGINE

- Stern drive down
- Equipment stored and balanced
- No gas smell in engine compartment
- Engine oil and steering fluid levels - OK
- Battery switch on
- No fluid in bilge
- Bilge pump working
- Bilge blower on
- Radio and navigation equipment functioning

#### PASSENGERS

- Wearing PFDs
- Seated properly
- Given safety instructions

#### STARTING ENGINE

- Make sure you have read and understand the dangers of Carbon Monoxide (CO) information in this manual.

- Bilge blower on for at least four (4) minutes. Feel to confirm airflow at hull vent on hull side. Inspect bilge area for visual and odor confirmation that there are no fuel leaks.
- Throttle-only position, handle pumped before starting, if necessary.
- Oil pressure, engine temperature, voltage - OK after starting and warm up.

#### UNDERWAY

- Gradual acceleration and deceleration and turning.
- Aware of surroundings at all times.
- Operate so as to prevent buildup of Carbon Monoxide (CO) (See section 1.4)
- Monitor weather
- Use navigational aids in water and on shore
- Keep passengers safe
- Do not operate impaired
- Check fuel consumption regularly
- Check all gauges frequently

#### END OF TRIP

- Equipment dry and stored.
- Electronic equipment and switches off.
- Battery switch off.
- Stern drive in trailering position.
- Notify person who had float plan.
- Boat covered properly for trailering, docking or mooring.
- Drain plug removed (if boat is not kept in water).
- Hull and propeller inspected for damage.

# SECTION 3 • USING YOUR BOAT

## 2. TRAILER LAUNCHING AND LOADING

### ! WARNING

An improper trailer can cause structural damage to the hull.

A damaged hull can be unsafe; it could cause the boat to sink.

Use a trailer that can properly support the boat's weight and shape. Get professional help in picking the right trailer for your boat.

Your trailer must be capable of carrying the boat's weight as well as supporting the boat near the keel, front (bow), and rear (stern) areas. Using a trailer not designed to support the boat properly, can cause structural damage to the hull. A damaged hull can be unsafe.

**PROPER TOWING OF A BOAT AND TRAILER REQUIRES SPECIAL SKILLS. MAKE CERTAIN YOU PRACTICE HOW TO MANEUVER A BOAT AND TRAILER AND GET TRAINING BEFORE TOWING, LAUNCHING, AND LOADING YOUR BOAT.**

## 3. FUELING THE BOAT

### ! DANGER

NO SMOKING

GASOLINE VAPORS ARE EXPLOSIVE

### NOTICE

GASOLINE RECOMMENDATIONS

Minimum octane rating of 87 AKI.

Refer to the engine owner's manual for additional information

### ! DANGER

Gasoline vapors can explode from static electricity if fueling is not done properly.

Read and understand this section and section 5 • Fuel System

FUEL FILL LOCATION  
(FIG. 3.2.1)

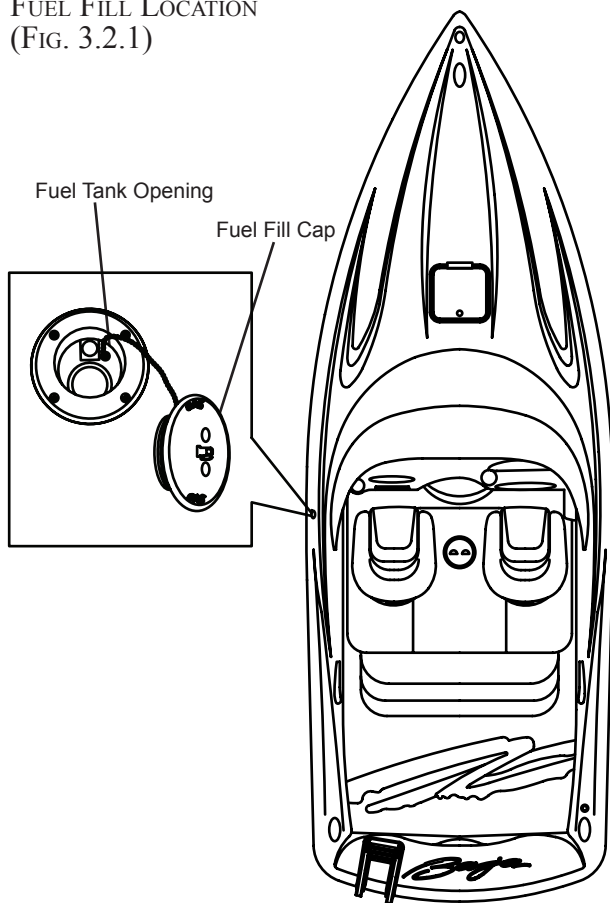

### ! WARNING

Leaking fuel is a fire and explosion hazard. Inspect system regularly. Examine fuel tanks for leaks or corrosion at least annually.

The fuel fill cap is located on the port side of the boat (Figure 3.2.1). **Do not mistake the water tank fill and waste pump out caps for the gasoline fill cap.**

Refer to your engine manual for the proper grade of gasoline.

### BEFORE FUELING

- Fuel during daylight hours.
- Tie boat to the dock.
- Shut off engine, bilge blower and all other electrical equipment.

---

## SECTION 3 • USING YOUR BOAT

---

- Shut off gas burning appliances (gas stove, etc.).
- Close all hatches, doors, and keep engine compartment closed to prevent gasoline fumes from entering the cabin or cockpit area.
- All passengers must leave the boat until it is refueled and engine is safely started.
- There must be no smoking or any flames within 20 feet of the boat, before, during, and for at least 5 minutes after fueling is completed.
- Open fuel fill cap and insert hose nozzle into the fuel fill opening. Fuel fill hose nozzle must contact the fuel fill opening **BEFORE** adding fuel to prevent discharge of static electricity.

### FILLING THE TANKS

- Check the fill plate label to ensure that fuel is placed **ONLY** in the fuel tank. The fuel fill plates are located on the port side of your boat (Figure 3.2.1).
- Keep nozzle in contact with fuel fill opening at all times during fueling.
- Listen as tank fills and stop adding fuel before it spills from the vent. Fuel must have room for expansion.
- Look for leaking fuel near fuel fill and near tank.

### AFTER FILLING

- **DO NOT** wash spilled fuel overboard. Wipe up any spill with rags or paper towels and dispose of them properly on shore.
- Open engine compartment and look for fuel leaks or smell for fumes. This is especially important if your boat is equipped with gasoline engines. Leave compartment open until no odor is apparent. Close compartment.
- If fumes in the engine compartment do not disappear, do not turn on blower or start engine. Get help from trained and experienced persons before using the boat.
- Turn on blower for four minutes, then restart engine.

- Assist passengers back into the boat.

## 4. BOARDING

### **WARNING**

**Wet decks are slippery.**

**You can be seriously injured if you slip and fall.**

**Wear slip-resistant footwear secured to your feet and hold onto rails or boat structure.**

- **DO NOT** overload the boat.
- Board one person at a time and give assistance as needed.
- Transfer gear and equipment by handing it from a person on the dock to a person on board. You can lose your balance and be injured if you attempt to board while carrying equipment or gear.
- Distribute the weight of equipment and passengers as evenly as possible to keep the boat balanced.
- Stow gear and equipment so that it is accessible, but everything is to be stored in places so as to prevent it from flying about if the boat encounters rough water or weather.

## 5. PERSONAL FLOTATION DEVICES (PFD's)

- Operator must instruct all passengers on location and use of PFD's (See *Section 1- Safety, page 4* for type and usage).
- Children and all non-swimmers, adults as well as children, must wear properly-sized PFDs at all times when aboard. Check applicable state regulations for PFD wear requirements.
- **ALL** passengers should wear PFDs. By the time someone falls overboard, it can be too late for them to put on a PFD and fasten it properly. This is especially true in colder waters, below 70°F, where survival time, before hypothermia sets in, is measured in minutes.

## SECTION 3 • USING YOUR BOAT

- If there are passengers not wearing PFDs, the PFDs must be readily accessible. “Readily accessible” means out of the storage bag and unbuckled.
- All throwable flotation devices (cushions, rings, etc.) must be right at hand.

### 6. PASSENGER INSTRUCTION AND LOCATION

- Everyone on board must be told about the boat’s behavior from starting to getting up on plane.
- Before the operator does any high-speed maneuvers or rapidly accelerates or decelerates the boat, passengers must be warned to sit and hold on and must heed the warning.
- The operator may have to make rapid changes in speed and/or direction to avoid a problem, with little or no time for alerting passengers. It is critical that all passengers be seated in the designated seating areas and holding on to prevent falling overboard or getting knocked about in the boat at all times when the boat is underway.

### 7. STARTING THE ENGINE

#### **DANGER**

**Gasoline vapors can explode**

**Before starting the engines, open engine compartment and check for gasoline smell.**

- **If you smell gasoline, do not start engine; get everyone off the boat and get trained help to find and fix the problem.**
- **If there is no gasoline smell, perform checks specified by manual, then and only then, close engine compartment and run blower for at least 4 minutes before starting.**

The engine operation and maintenance manual furnished with your boat describes pre-start and starting procedures. We urge you to thoroughly read and understand your engine manual.

Listed below are basic pre-start and starting reminders. These are not a substitute for the engine manufacturer’s specific recommendations.

Open the engine compartment and check for the smell of gasoline.

- **IF YOU SMELL GASOLINE**, get everyone off the boat, do not operate any electrical switches or light any matches, lighters, etc. Get trained help to find and fix the problem, before starting the engine or operating any switches on the boat.

- If you **DO NOT** smell gasoline:

1. Check all fluid levels and any other necessary checks as specified in Section 8 and in the engine manual.
2. Check that water level in bilge is minimal. Verify that the bilge pump is operating by turning the bilge pump switch to **MANUAL** and listening for the pump running and check to see that bilge water is being pumped overboard.
3. Close engine compartment.
4. Check fuel level. Be sure you have enough fuel for your trip. Remember the “1/3 Rule”: Use no more than 1/3 of your fuel for outbound trip; use 1/3 of the fuel for return trip; keep 1/3 for reserve in case of emergency (FIG 3.4.1).
5. Run bilge blowers for at least 4 minutes before attempting to start engine (FIG 3.4.2).

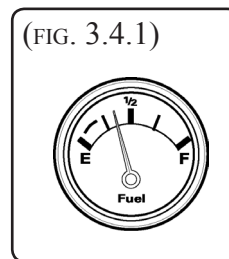

Unlike your automobile engine which is naturally ventilated even when it is not moving, your boat engine compartment (the bilge) does not have sufficient natural ventilation when the boat is not moving or moving slowly. That is why the engine compartment must have forced ventilation, using the bilge blower, to remove potentially explosive gasoline vapors before the engine is started and when the boat is moving slowly.

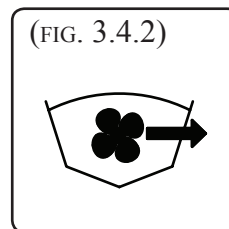

Because it may be difficult to remember to turn on the bilge blower every time you slow down the boat,



## SECTION 3 • USING YOUR BOAT

it is recommended that the bilge blower run all the time the engine is running.

6. Place drive unit in full DOWN/IN position.
7. Put shift control lever into neutral; then for a:

**COLD ENGINE** - Move throttle lever forward to full open throttle, then return to about 1/4 throttle. In cold weather, it may be necessary to pump lever several times before engine will start.

**WARM ENGINE** - Move throttle lever about 1/4 open throttle position. Do not pump lever.

**FLOODED ENGINE** - Move throttle lever to full open position. **DO NOT** pump lever. When the engine starts, move throttle lever back rapidly to decrease engine speed to between 1000 and 1500 RPM.

### 8. TO START ENGINE:

Turn ignition keys clockwise, as you would an automobile (Fig. 3.5.1).

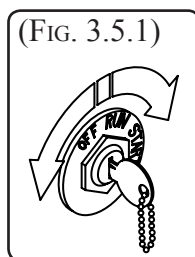

9. After engine starts, reduce speed to between 1000 and 1500 RPM and check oil pressure.

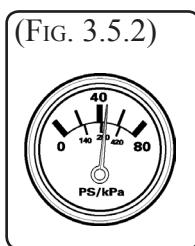

10. If oil pressure is correct, let engine warm up to normal temperature range as specified in the engine manual, before shifting into forward or reverse gear (Fig. 3.5.2).

**IF ENGINE TEMPERATURE GOES ABOVE NORMAL RANGE. SHUT DOWN THE ENGINE IMMEDIATELY. GET TRAINED HELP TO FIND AND FIX THE PROBLEM** (Fig. 3.5.3).

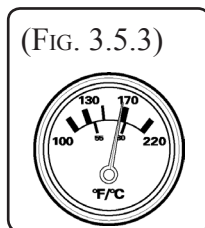

**IF OIL PRESSURE GOES ABOVE OR BELOW OPERATING RANGE, SHUT ENGINE DOWN IMMEDIATELY. GET TRAINED HELP TO FIND AND FIX THE PROBLEM.**

## 8. SHIFTING TO DRIVE THE BOAT

Bring throttle lever all the way back. Once done, the drive is ready to shift.

Move shift lever either forward or reverse. Then move throttle lever forward, the drive unit will engage and boat will start to move slowly in either forward or reverse. Once clear of the dock, mooring, people and/or the no-wake zone and the boat has been shifted into forward gear, move throttle lever forward to desired engine speed.

### ! CAUTION

**Cockpit can fill with water if boat is moving forward, when it is put into reverse.**

**Before shifting into reverse, shift to neutral, wait for the boat to stop moving forward, then shift into reverse.**

## 9. STOPPING THE ENGINE

1. Move throttle lever all the way back. Once done, move shift lever to neutral position, which is located in the center. (Fig. 3.5.4).

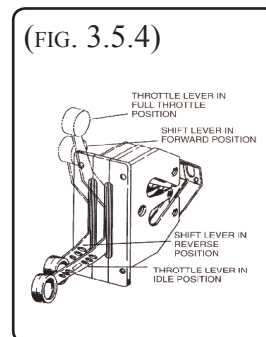

2. Turn ignition keys counter clockwise to turn off engine (Fig. 3.5.5).

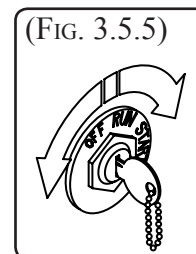

3. If you are leaving the boat for more than two hours, turn battery switches OFF (Fig. 3.5.6)

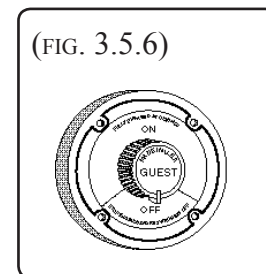

## SECTION 3 • USING YOUR BOAT

### 10. STEERING SYSTEM

#### WARNING

Failure of the steering system will cause loss of control of your boat. Any change in steering such as looseness, tightness, binding, etc., must be checked immediately by your Baja dealer.

The steering system is an enclosed push-pull cable that is hydraulically assisted (power steering) at the stern drive end (Fig. 3.6.1). THE CABLE AND ITS CONNECTIONS TO THE STEERING WHEEL AND TO THE OUT DRIVE MUST BE INSPECTED AT LEAST TWICE A YEAR BY YOUR BAJA DEALER. See section 8 of this manual for inspection, service and maintenance recommendations.

The power steering pump fluid level MUST be checked every time prior to using the boat. Refer to the steering system information in your Owner's Packet.

POWER STEERING SYSTEM  
(FIG 3.6.1)

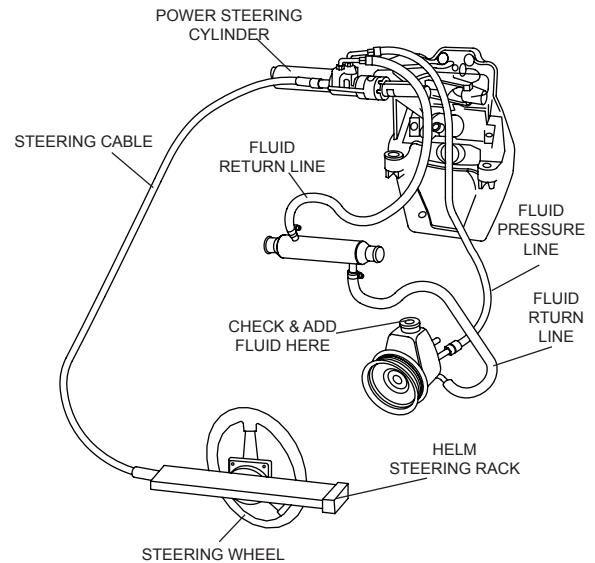

# SECTION 4 • BILGE & UNDERWATER GEAR

## 1. BILGE

### A. FUEL & OIL SPILLAGE

Regulations prohibit discharging fuel or oily waste in navigable waters. Discharge is defined as any action which causes a film, sheen or discoloration on the water surface, or causes a sludge or emulsion beneath the water surface. A common violation is bilge discharge. Use rags or sponges to soak up fuel or oily waste, then dispose of it properly ashore. If there is much fuel or oil in the bilge, contact a knowledgeable marine service to remove it. Never pump contaminated bilge overboard.

Fill fuel tank less than rated capacity. Allow for fuel expansion.

### B. DRAIN PLUG

The bottom of the engine compartment is called the “bilge”. It is the lowest and inner part of the hull. Water and other liquids will collect here.

After removing your boat from the water, unthread the drain plug to drain the bilge (Figure 4.1.1).

### ! DANGER

Install and tighten drain plug before launching boat.  
Boat will sink if drain plug is not in place and tight.

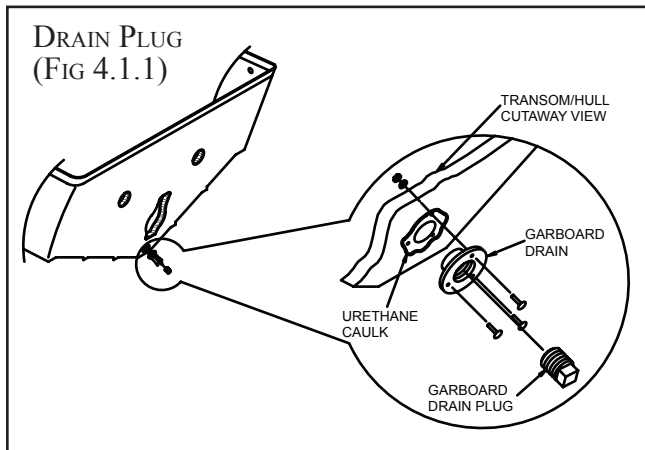

## C. BILGE PUMPS

### ! WARNING

Sinking Hazard – Ensure the bilge pumps are operating properly.

### ! CAUTION

Run bilge pumps in the manual position only as long as necessary to remove water. Running bilge pumps dry can damage the pump motor.

A bilge pump and float switch are located in the bottom of the bilge (Figure 4.1.2). The bilge pump is manually activated from the switch panel located on the helm.

BILGE PUMP AND FLOAT SWITCH (FIG 4.1.2)

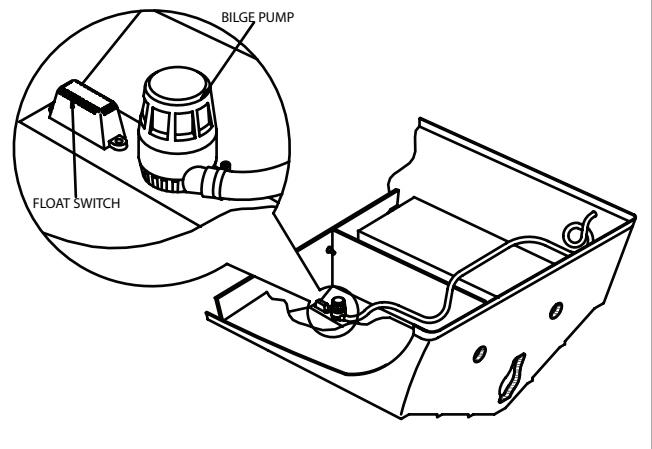

Before starting the engine, press the bilge pump switch so that the switch light comes ON. Make sure the pump is working by opening the engine compartment, listening to hear the pump running and check to see that liquid is being pumped out from the hull discharge. If the bilge has more liquid than normal, see Maintenance Section for locating and correcting the problem.

---

## SECTION 4 • BILGE & UNDERWATER GEAR

---

Except for checking the operation of the bilge pump using the ON position, leave the switch in the OFF (AUTO) position. In the OFF (AUTO) position, when the bilge liquid is deep enough to activate the float switch, the bilge pump turns on and pumps out the bilge liquid until the float switch drops and shuts off the pump.

**If the liquid level in the bilge is higher than normal and the bilge pump empties the bilge when you use the ON switch, the float switch is not operating properly. Have it checked immediately. If the ON switch does not operate the pump, DO NOT use the boat until the problem is corrected.**

The emergency high water bilge pump and float switch are wired to the high water bilge alarm. Should the pump be activated by water in the sump, the alarm will sound. If alarm sounds, immediate attention to the engine room is required.

### Maintenance

Frequently inspect the area under the float switches to ensure they are free from debris and gummy bilge oil. To clean, soak in heavy duty bilge cleaner for 10 minutes, agitating several times. Check for unrestricted operation of the float. Repeat the cleaning procedure if necessary.

**Inspect the bilge pump intakes and keep them free of dirt or material which may impede the flow of water through the pump.**

### D. BILGE BLOWER(S)



#### WARNING

**EXPLOSION/FIRE HAZARD – Run blower at least four (4) minutes before starting engine or generator. Check bilge and engine compartment for fumes.**



#### WARNING

**Do not allow obstructions to interfere with bilge blower or ventilation intake operation. Engine performance may be adversely affected.**

To prevent buildup of gasoline fumes to the explosive level in the engine compartment, the bilge blowers must be run for at least four (4) minutes before starting the engine and kept running at all times when the engine is running to insure that there will be adequate ventilation when you are moving slowly. The blowers may also remove deadly carbon monoxide (CO) which may be in the bilge. **Run blowers when using the generator or engine.**

## 2. ENGINES AND STERN DRIVE

### A. MAINTENANCE AND SERVICE

**Engine failure away from shore can be dangerous.** You must follow the recommended maintenance schedule to best ensure trouble-free operation of your engine and stern drive.

### B. VIBRATION AND CAUSES

Some vibration is to be expected in your boat because of the action of the engines and the propeller. But excessive vibration indicates conditions which must be promptly corrected to avoid damage. The following are some conditions which may cause vibrations.

- Weeds, ropes, fishing lines, nets or your own trailing lines can become wrapped around the propeller and/or shaft, causing vibration and loss of speed. Always stop the boat, make sure it is clear to the rear, and then reverse the propeller after going through a weedy area to unwrap and clear away any weeds which may have accumulated. If this doesn't clear the entanglement, and you can't anchor or moor the boat in shallow water to get to the stern drive in the water, the boat will have to be taken out of the water.
- A badly damaged or distorted propeller or shaft is an obvious cause of vibration. Run at slow speed to shore. REPLACE IMMEDIATELY.
- If the engine mounts fail and the engine can contact the hull while it is running, vibration will be felt. Run at slow speed to shore. REPLACE IMMEDIATELY.

## SECTION 4 • BILGE & UNDERWATER GEAR

### C. IMPACT TO STERN DRIVE

The stern drive can be damaged by impact, either while trailering or boating. To minimize the possibility of impact damage while trailering, keep the stern drive raised to the trailering position.

The hydraulic system used to raise and lower the stern drive can cushion impact and lessen damage from head-on impacts to the stern drive from underwater objects BUT ONLY when the boat is moving forward. There is no protection if the stern drive is struck during reverse operation or from an angle when moving forward.

If you strike a submerged object, STOP THE ENGINE as soon as possible and examine the stern drive unit for damage. Even if no damage is visible, there could be internal problems or difficulty maneuvering. If you must use the boat after impact, run at the lowest speed possible.

### D. PROPELLER REMOVAL AND INSTALLATION

#### **! WARNING**

If engine is started during propeller maintenance, serious personal injury can occur.

Shut off engine, remove key, shift into neutral, and put tape over ignition switch key slot.

- Shut off engine, remove key, shift into neutral and put tape over ignition switch key slot.
- Straighten the bent tabs on the propeller nut retainer (Figure 4.3.1).

PROPELLER  
(FIG. 4.3.1)

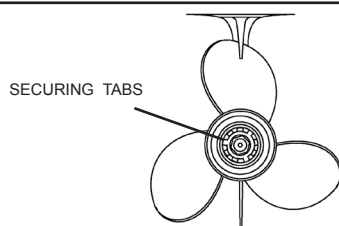

- Place a block of wood between the gear case and propeller to stop propeller from rotating and remove propeller nut (Figure 4.3.2).

PROPELLER  
(FIG. 4.3.2)

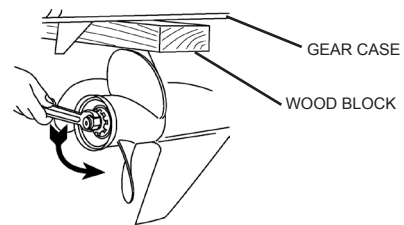

- Remove the propeller nut retainer, the thrust hub and the continuity washer (Figure 4.3.3) and put them in a secure place. Pull the propeller straight off the shaft. Remove the thrust washer that is behind the propeller. If the propeller is seized to the shaft and cannot be removed by hand, special tools are needed. Have the propeller removed by an authorized dealer or trained mechanic.

PROPELLER  
(FIG. 4.3.3)

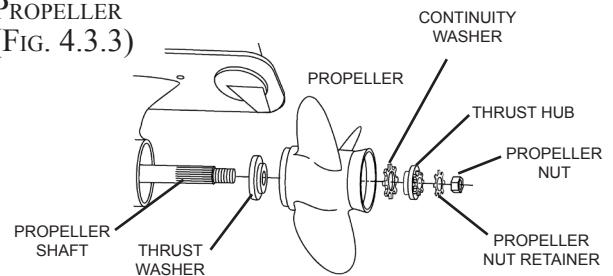

- Coat the propeller shaft with an anti-seize lubricant (Figure 4.3.4).

PROPELLER  
(FIG. 4.3.4)

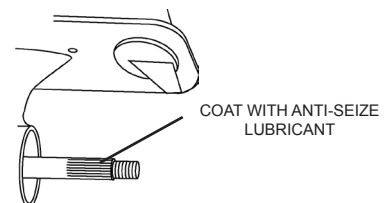

## SECTION 4 • BILGE & UNDERWATER GEAR

- f. Install the thrust washer, propeller, continuity washer, thrust hub, propeller nut retainer and the propeller nut onto the shaft (Figure 4.3.3).
- g. Place a block of wood between the gear case and the propeller (Figure 4.4.1) and torque the propeller nut to recommended manufacturer's specifications. The correct propeller nut torque is given in your Engine Operator's Manual in the Owner's Manual Packet.
- h. Secure the propeller nut by bending three (3) of the tabs of the propeller nut retainer into the thrust hub grooves (Figure 4.4.2).

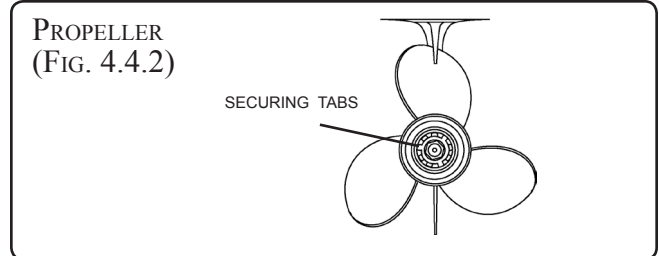
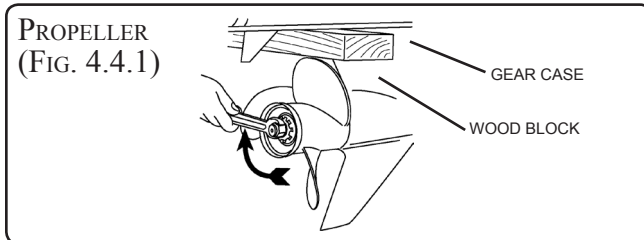

# SECTION 5 • FUEL SYSTEM

## 1. FUEL SYSTEM



Section 3 • Using Your Boat contains important fueling information. Take time to read all the fuel related information in the owner's manual.

The H2X standard gasoline fuel system consists of a 80 gallon fuel tank, fuel tank vent, an anti-siphon valve, engine fuel supply line and fuel fill (See Figure 5.1.1).

The fuel tank vent serves as a pressure/vacuum release and safety overflow. The fuel vent is located inside the fuel cap on the port side of the hull. Periodically check the vent to assure that it is not clogged.

### CAUTION

Never start an engine until you are certain that fuel fumes are not present in engine compartment or elsewhere in the boat.

## ANTI-SIPHON VALVE (INBOARD/OUTBOARD ENGINE ONLY)

The fuel pick-up at the fuel tank has an anti-siphon valve to prevent fuel from siphoning out in the event of line failure (See Figure 5.1.1 and 5.1.2). In an emergency situation, remove the anti-siphon valve if the engine is not getting fuel. NOTE: Replace with new anti-siphon valve or fuel shut off valve as soon as possible as anti-siphon protection is required by federal law.

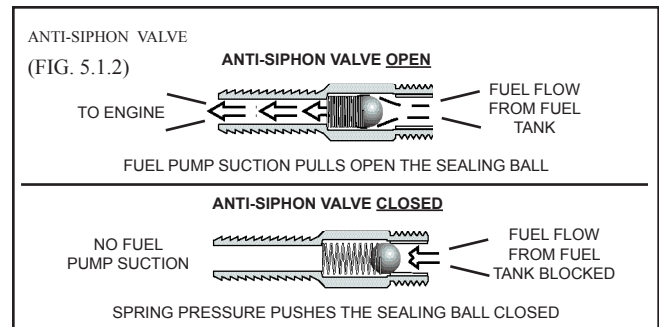

SINGLE ENGINE GAS FUEL SYSTEM (FIG 5.1.1)

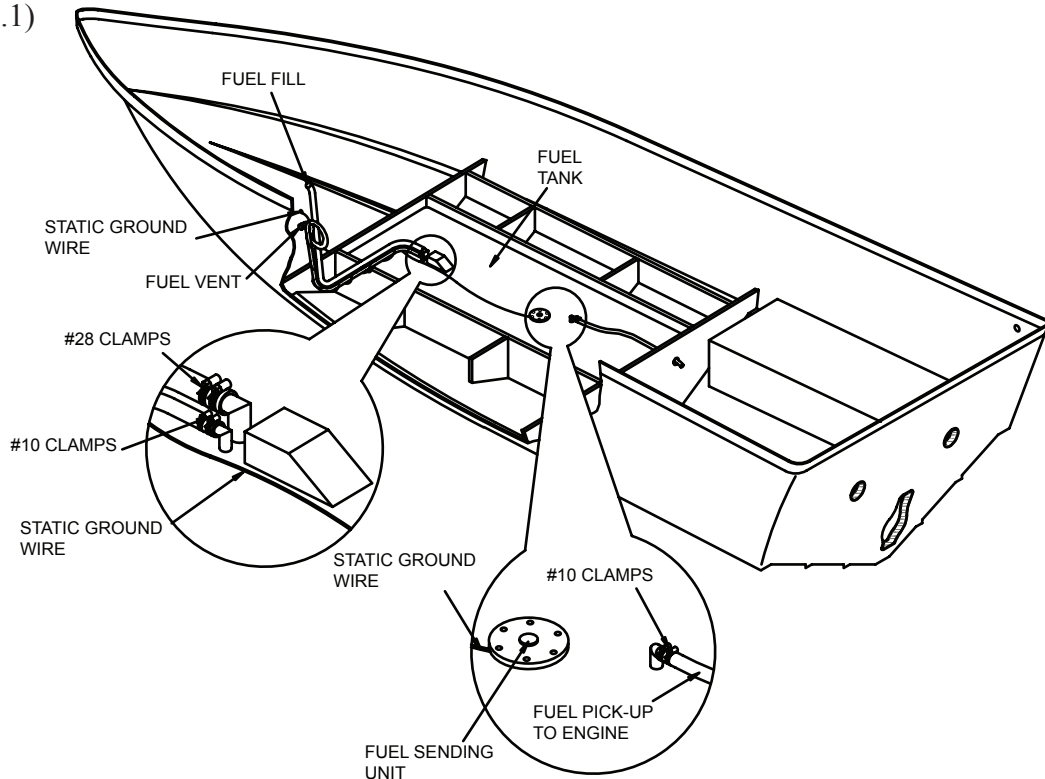

---

## SECTION 5 • FUEL SYSTEM

---

### 2. FUELING PRECAUTIONS

Certain precautions must be carefully and completely observed every time a boat is fueled, even with diesel fuel. Diesel fuel is nonexplosive but it will burn.

#### A. STATIC ELECTRICITY AND THE FUEL SYSTEM

There is a danger that static electricity can ignite gasoline vapors that have not been ventilated outside an enclosed area. Use extreme caution when fueling your boat from a source outside the regular venues.

Your boat has safety features that can be circumvented by not adhering to standard fueling practices.

Your boat's bonding system is designed to dissipate the build-up of static electricity.

Your boat must be in contact with the water or a land based grounding system. Here are some helpful suggestions to keep you safe from static electricity while refueling your boat.

- NEVER fuel your boat in unsafe conditions such as: suspended on a sling or in a situation that increases the likelihood of static discharge.
- NEVER use homemade containers to fill your fuel tank.
- Fuel carried onboard, outside of a fixed fuel system should be stored in an approved container or in a portable tank, such as provided for outboard engines, and be stowed safely outside of the engine or living compartments.
- Shutdown the engine, motors, and fans prior to taking on fuel. Any ignition sources should be extinguished before filling the fuel tank.
- Close all ports, window, doors, and hatches to prevent gas fumes from accumulating in the cabin.
- Fueling should never be done at night except in well-lighted areas.

- Always keep the fuel nozzle in contact with the fuel fill plate or the edge of the fuel tank opening throughout the filling process.
- Allow areas where gasoline vapors could collect to be ventilated before starting the engine.
- Wipe any spillage completely and dispose of rags or waste on shore.
- Secure the fill cap tightly.
- Fuel tank should never be filled to capacity. Allow for fuel expansion.
- Portable tanks should only be filled while on the ground; never onboard the boat.

#### B. GENERAL:

- Check fill plate label to ensure fuel is placed only in fuel tank. Fuel fill plate is located on the port side of the boat.
- Avoid spills.
- Know your fuel capacity and consumption. Record the amount of fuel used since your last fill up, and compute the engine's hourly fuel usage. As a fuel gauge backup check, deduct the average hourly fuel usage from fuel tank capacity.
- Observe the "Rule of Thirds": one-third fuel for trip out, one-third for return and one-third for reserve.
- Allow an additional 15 percent fuel reserve when operating in rough seas.

#### C. BEFORE AND DURING FUELING – CHECKLIST:

- Fire extinguisher – close at hand.
- Mooring – boat tied securely to fueling pier.
- Crew – at least one knowledgeable person present.
- Passengers – unnecessary people off the boat.
- Engines – stopped.



## SECTION 5 • FUEL SYSTEM

- Electrical equipment, including blowers – power off.
- Doors, hatches – closed.
- Smoking material – extinguished.
- Inboard tanks – grounded.
- Filler pipe – marked GAS or DIESEL.
- Fuel nozzle – in contact with filler pipe to prevent static sparks.
- Fill level – fill less than rated capacity of tank; allow for fuel expansion.
- Trim – fuel weight distributed equally.

### D. AFTER FUELING – CHECKLIST:

- Doors, hatches – open.
- Sniff test – if fuel fumes remain, operate blowers until fumes are gone.
- Fuel tank – secure filler cap.
- Spills – wipe; dispose of rags ashore.

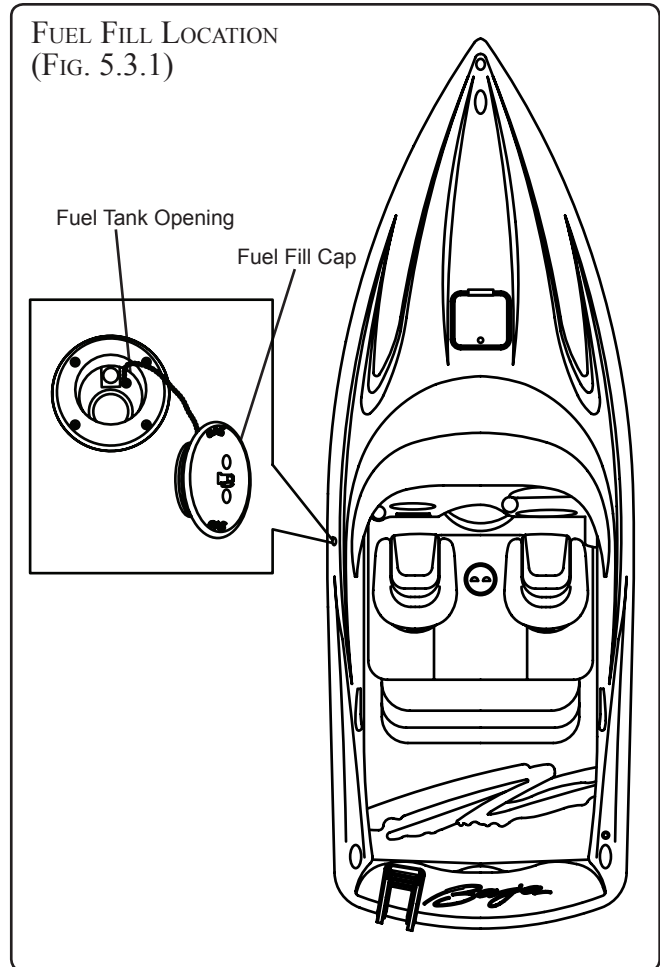

---

## SECTION 5 • FUEL SYSTEM

---

THIS PAGE INTENTIONALLY LEFT BLANK

# SECTION 6 • ELECTRICAL SYSTEMS

## 1. ELECTRICAL SYSTEMS

### DIRECT CURRENT (DC)

The 12 volt direct current (DC) electrical system (similar to that in your car or truck) derives its power from the battery. An engine-driven alternator keeps the battery in a charged condition. The battery voltage is indicated by the voltmeter on the helm panel. The negative terminal of the battery is attached to the grounding studs of the engine.

Ask your dealer for a careful analysis of DC power needs on your boat. It may be necessary to add batteries or auxiliary charging methods to supply adequate power for any additional accessories you wish to add.

#### A. BATTERIES

##### DANGER

**DO NOT USE JUMPER CABLES IN THE ENGINE COMPARTMENT.**

They can cause an explosion from sparks.

##### DANGER

**A battery will explode if a flame or spark ignites the free hydrogen given off during charging.**

**Never use an open flame or strike sparks in the battery area.**

The battery installed in your boat has been selected for its ability to furnish starting power based on engine starting requirements, as well as its ability to power the DC accessories attached to the electrical system. Your Engine Operator's Manual indicates the recommended battery for the engine installed in your boat.

##### CAUTION

**To prevent arcing or damage to the alternator, always disconnect battery cables before doing any work on the engine's electrical system.**

To remove the battery cables:

1. Turn off all items drawing power from the battery.
2. Remove the negative cable first, then the positive cable. To replace the cables, first replace the positive cable, then the negative.

#### Battery Maintenance

- Check the fluid level in the cells approximately every 4 weeks, and weekly in summer and hot zones.
- The fluid level must be between the lower and upper markings.
- Replenish only with distilled water. Do not use metal funnels.
- Coat battery terminal clamps with silicone grease. Keep batteries clean and dry.

Battery life is shortened if it is drained to zero charge before recharging. It is recommended that a battery not be discharged more than 50 percent. If the battery does become run down, recharge it as soon as possible.

Running the engine to recharge the battery may not be effective. The alternator only creates charging power at higher engine speeds, so simply idling or trolling will not generate enough power to recharge the battery.

If you need to charge a battery, only use a battery charger designed to charge automotive/marine batteries. Use charger only when batteries are disconnected from the boat's electrical circuit. Follow the charger instructions.

If your boat will not be used for several weeks or more, remove the batteries from the boat and connect them to a charger.

#### B. IGNITION PROTECTION

All electrical components in the engine compartment **must** be ignition-protected to avoid the possibility of creating sparks in a gasoline environment.

## SECTION 6 • ELECTRICAL SYSTEMS

### DANGER

#### GASOLINE VAPORS CAN EXPLODE

Use **ONLY** Marine-rated parts to replace such items as starters, distributors, alternators, generators, etc.

Do not use automotive parts for these components or any jumper cables because they are not ignition-protected and could cause a fire or explosion.

Protective terminal covers, such as rubber boots on electrical connections, must be in place when engine is operating or when working in the engine compartment.

Jumper cables are not ignition-protected. **DO NOT USE** jumper cables in the engine compartment. The engine compartment may accumulate dangerous explosive gasoline fumes/vapors and hydrogen gas from batteries being charged. A spark produced when connecting a jumper cable can cause an explosion.

### C. BREAKERS AND/OR FUSES

If you need to replace a fuse or breaker, **use only the same amperage as the original, and one that is rated for marine use.** It is recommended that you carry spare fuses.

If a fuse or breaker is replaced with one of lower amperage, it will be insufficient to carry the electrical load of the equipment it is connected to and will

### WARNING

Use of higher amperage fuses or breakers is a fire hazard.

Use fuses and breakers having the same amperage rating as the original or as specified.

cause nuisance fuse failure or breaker tripping.

If a breaker or fuse is replaced with a breaker or fuse of higher amperage, it will not provide adequate protection against an electrical malfunction and will create a fire hazard.

The fuses are color coded according to the

amperage and the rating is also marked on each fuse.

FUSE CONDITION (ATO TYPE FUSE)  
(FIG. 6.2.1)

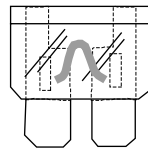

GOOD FUSE

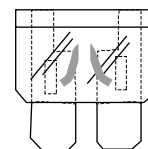

BLOWN FUSE

### D. FUSE PANEL

Your boat has an illuminated waterproof electronic switch pad to control lights, bilge pump and other accessories. The switch pad is connected to the fuse panel located under the dash. The fuse panel uses automotive type fuses to protect these accessories.

REPLACE ONLY WITH A FUSE OF THE SAME AMPERAGE. The amperage is marked on the side of the fuse.

## 2. ELECTROLYTIC CORROSION & ZINC ANODES

Electrolytic corrosion of metals on power boats can result in rapid and serious deterioration of metal parts. You must set a regular schedule and look for the possibility of electrolytic corrosion (the deterioration of metals due to dissimilar characteristics when placed in salt water). It is your responsibility to check for and replace parts damaged due to electrolytic corrosion.

To minimize electrolytic corrosion of the metals on your boat, zinc anode plates are provided on your boat to protect underwater hardware. Zinc, being much less "noble" than the copper-based alloys and aluminum used in underwater fittings, will deteriorate first and protect the other metals.

Stern drives are fitted with zinc anodes on their lower units (refer to your Engine Owner's Manual for their locations). If boat is equipped with Mercathode® stern drive will not have zincs.

## SECTION 6 • ELECTRICAL SYSTEMS

Zinc anodes require replacement about every six months, if the boat is operated in salt water. In fresh water, the zinc anodes can be replaced about once a year.

If the anodes deteriorate more rapidly than this, there is probably a stray current problem within the boat or at the slip or mooring.

If the anodes do not deteriorate, they are not protecting the other metallic parts of your boat. This can be caused by loose anodes or by low grade zinc or by not having a solid electrical contact between the anode and the metal it contacts, or by paint on the anodes.

If the anodes are deteriorating rapidly, or not at all, contact your dealer.

### NOTICE

**DO NOT PAINT BETWEEN THE ZINC AND THE METAL IT CONTACTS, AND DO NOT PAINT OVER THE ZINC.**

### 3. MARINE ELECTRONIC CATHODIC ANTI-CORROSION SYSTEM (MERCATHODE®)

The automatically controlled Cathodic Anti-Corrosion System for marine installation protects underwater metals from the effects of corrosion and electrolysis on stern drives. The system components are designed for marine service. **DO NOT PAINT THE MERCATHODE® SYSTEM.**

The anode and reference electrode are attached to the electrode assembly under each stern drive unit. The solid state controller is mounted within a plastic housing on the transom in the bilge.

MERCATHODE ILLUSTRATION (EXAMPLE)  
(FIG 6.3.1)

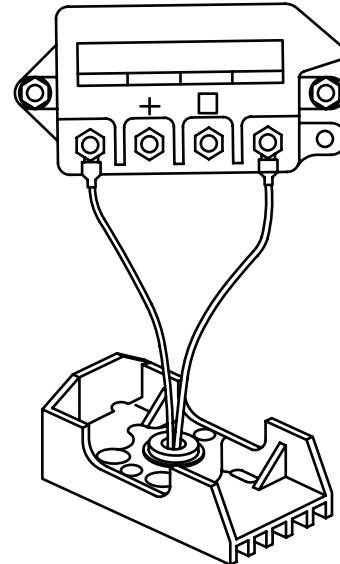

#### Maintenance

The Mercathode® system must be tested to ensure adequate output. The test should be performed every 100 hours or annually. Contact your authorized Baja® dealer to arrange for this test. Refer to the engine operator's manual for more detailed information.

### 4. ELECTRICAL SYSTEMS

This owner's manual contains electrical schematics and wiring harness illustrations for your boat. These electrical schematics were generated by electrical CAD designers at the engineering division for technical reference and service technicians. Baja® does not recommend that you attempt to work on the boat's electrical system yourself. Instead, we recommend that you take your boat to your authorized Baja® dealer for service. Baja® reserves the right to change or update the electrical system on any model at any time without notice to the consumer and is NOT obligated to make any updates to units built prior to changes.

# SECTION 6 • ELECTRICAL SYSTEMS

DRIVE PUMP  
(FIG. 6.4.1)

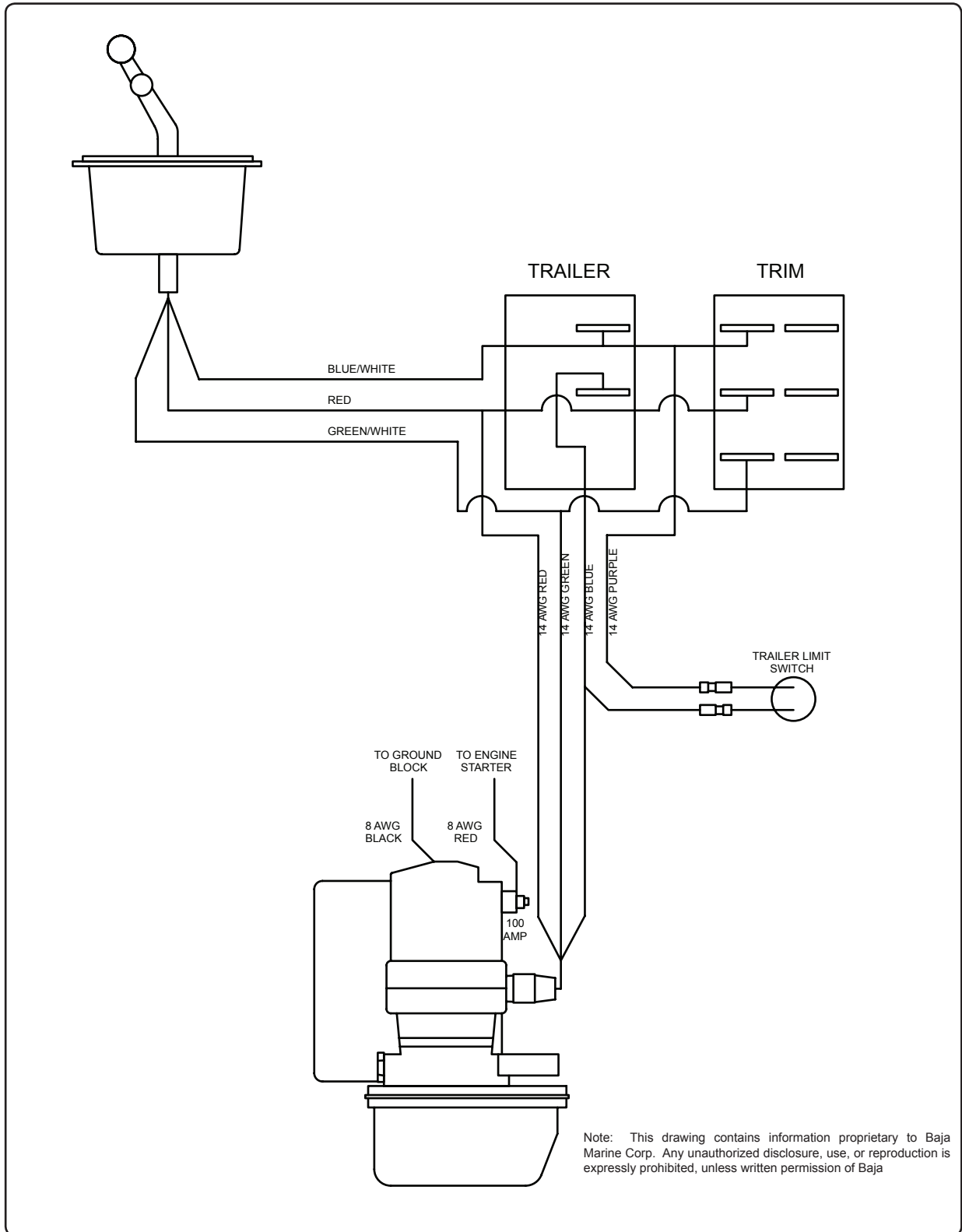

# SECTION 6 • ELECTRICAL SYSTEMS

DRIVE PUMP W/ K-PLANE TRIM TABS  
(FIG. 6.5.1)

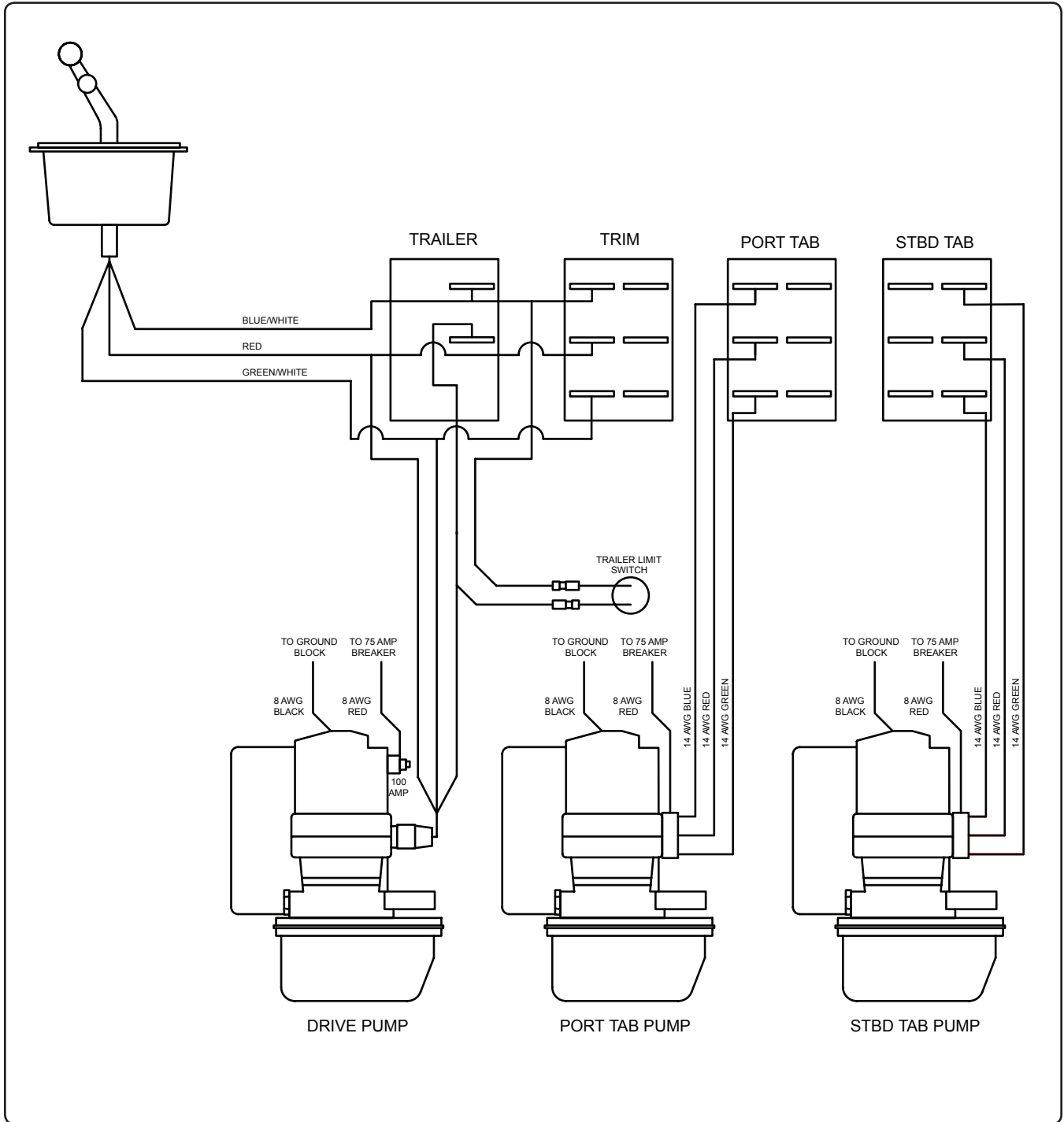

Note: This drawing contains information proprietary to Baja Marine Corp. Any unauthorized disclosure, use, or reproduction is expressly prohibited, unless written permission of Baja

# SECTION 6 • ELECTRICAL SYSTEMS

IGNITION SWITCH  
(FIG. 6.6.1)

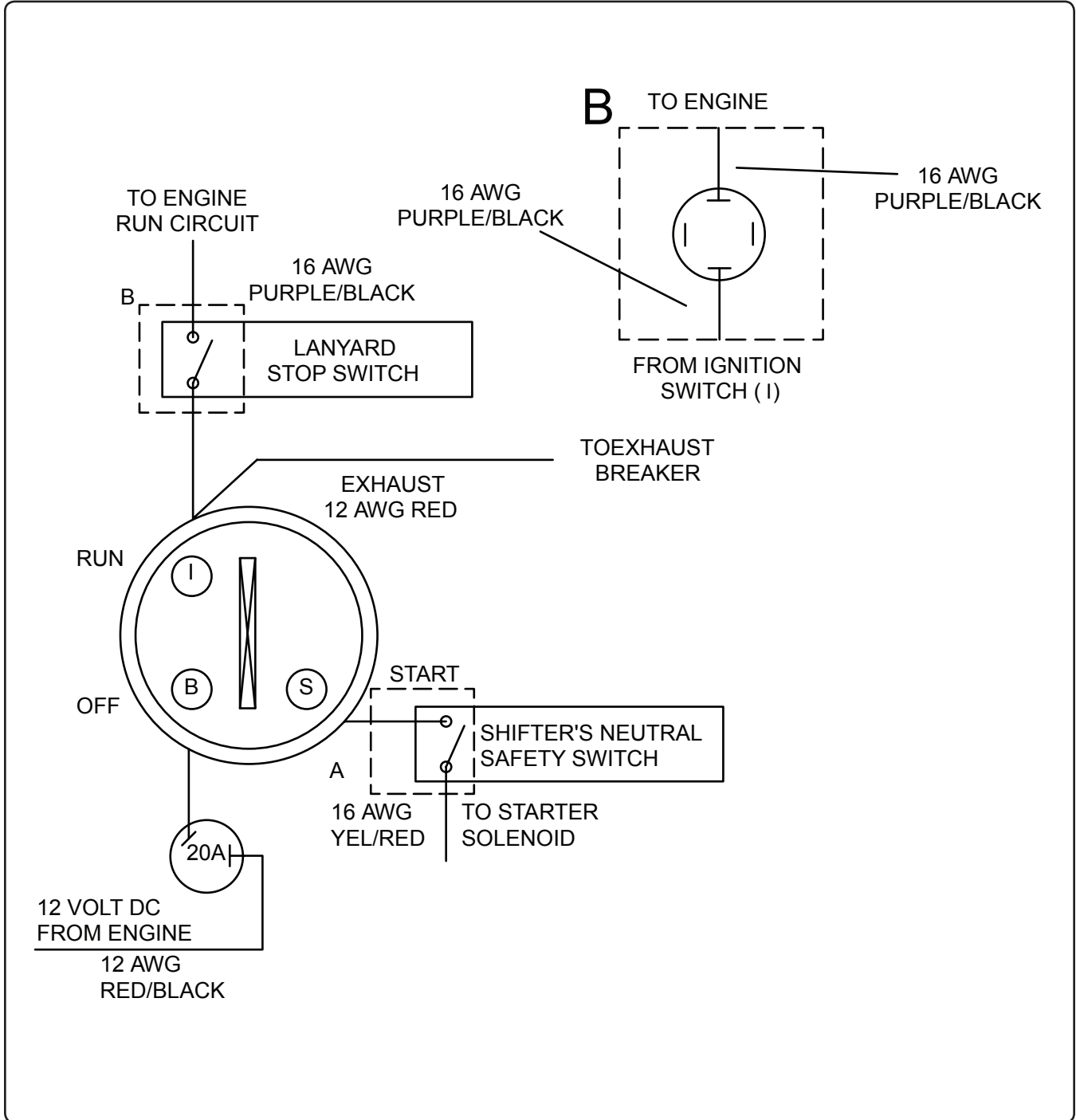

Note: This drawing contains information proprietary to Baja Marine Corp. Any unauthorized disclosure, use, or reproduction is expressly prohibited, unless written permission of Baja



# SWITCH PANEL WIRE INFORMATION (FIG. 6.7.1)

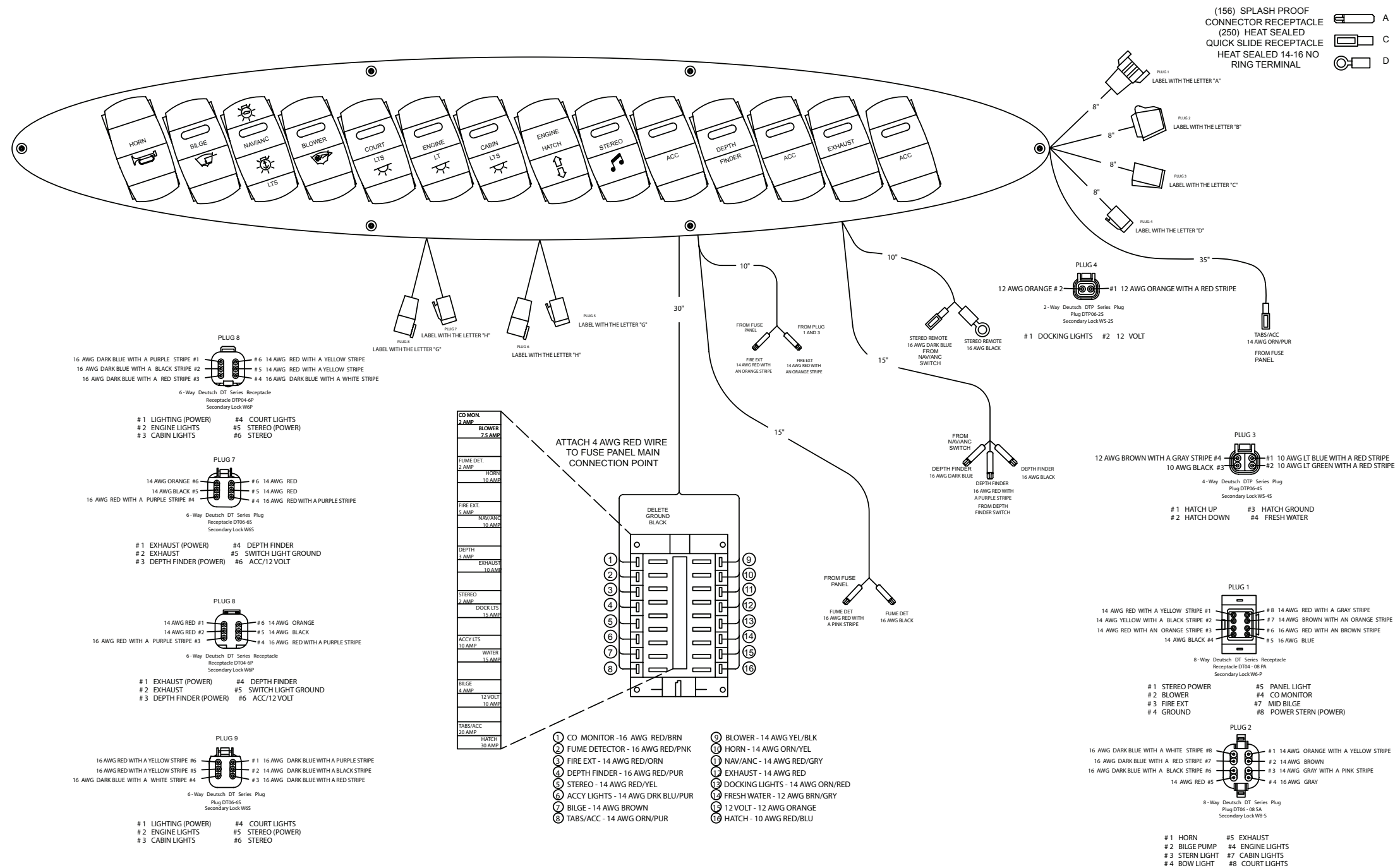

THIS PAGE INTENTIONALLY LEFT BLANK



---

# SECTION 7 • OPTIONS & ACCESSORIES

---

## 1. OPTIONS & ACCESSORIES LOCATIONS

Figure 7.1.1 shows the location of some of the components. Take time to walk through your boat, locate the features, and become familiar with their operation and maintenance.

### STANDARD & OPTIONAL EQUIPMENT LOCATIONS (FIG. 7.1.1)

<b>Item</b>	<b>Location</b>
6 - Disc CD Changer	Cuddy, Port Side Under Seat
12V Receptacle	Dash - Passenger Side (Port)
Anchor Holder w/ Strap	Engine Compartment - Port Side
Auto Bilge Pump	Engine Compartment - Under Engine
Battery Tray	Engine Compartment - Strb Side on Floor
Blower	Engine Compartment - Strb Side on Transom Wall
Courtesy Lights	Cockpit - Side Panels
Depth Finder (Opt.)	Dash - Driver Side (Strb) above Switch Panel
Freshwater Flush (Opt.)	Engine Compartment - Strb Side, Under Starter
Fuel Fill & Vent Combo	Midship - Port Side
Fuel Tank	Cockpit - Under Center Floor
Fume Detector (Opt.)	Gauge - Driver Side (Strb) Dash; Detector - Engine Compartment
Fuse Panel	Under Dash - Strb. Side
Garboard Drain Plug	Transom - Under Drive Unit
Horn	Bow - Strb Side
Hour Meter	Dash - Integrated into Tachometer
Port-A-Pot (Opt.)	Cuddy, under V-berth
Safety Switch w/ Lanyard	Dash - Right Side of Shifter
Stereo	Dash - Passenger Side (Port)
Stereo Amp.	Under Rear Bench
Stereo Remote	Driver Side (Strb) Dash
Swimplatform (Opt.)	Transom - Above Drive Unit
Switch Panel	Dash - Above Shifter
Transom Shower (Opt.)	Strb. Stern above Swimplatform
Trim Tab Indicator	Driver Side (Strb) Dash

# SECTION 7 • OPTIONS & ACCESSORIES

## 2. AUTOMATIC FIRE EXTINGUISHER SYSTEM (OPTION)

The H2X may be equipped with an automatic fire extinguisher system located aft of the engine on the transom. In the event of a fire, the heat sensitive automatic head will release the extinguishant as a vapor, totally flooding the area in fire-killing concentrations. The system indicator light is wired to the battery and is constantly on to safeguard your boat.



The indicator light, located on the dash, indicates to the helmsman when the unit has discharged. Under normal circumstances, the charge indicator light is lit. If the unit discharges, the light will go out.

**WHEN DISCHARGE OCCURS, IMMEDIATELY SHUT DOWN ENGINE, POWERED VENTILATION, ELECTRICAL SYSTEMS AND EXTINGUISH ALL SMOKING MATERIALS. DO NOT IMMEDIATELY OPEN THE ENGINE COMPARTMENT!! THIS FEEDS OXYGEN TO THE FIRE AND FLASHBACK COULD OCCUR.**

Allow the extinguishant to "soak" the compartment for at least fifteen (15) minutes and for hot metals or fuels to cool before cautiously inspecting for cause of damage. Have portable extinguishers at hand and ready. Do not breathe fumes or vapors caused by the fire.

REFER TO OWNER'S MANUAL PACKET FOR INSTRUCTIONS AND WARRANTY INFORMATION ON FIRE EXTINGUISHER SYSTEM.

## 3. FIRE EXTINGUISHER PORT

Boats not equipped with the automatic fire extinguisher option are equipped with a fire extinguisher discharge port (See Figure 7.2.2). In the event of a fire, a fire extinguisher can be inserted through the port and discharged into the engine compartment without having to open the

engine box. Do not open the engine compartment immediately! This feeds oxygen to the fire and flashback could occur.

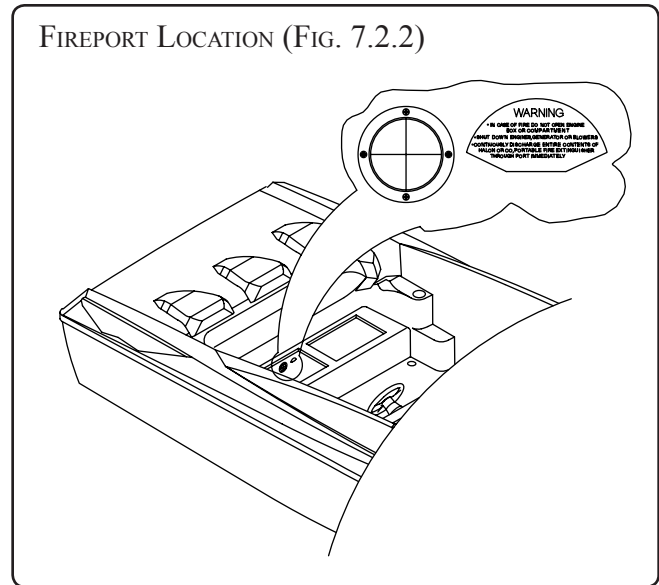

**IF A FIRE OCCURS, IMMEDIATELY SHUT DOWN ALL ENGINES, POWERED VENTILATION, ELECTRICAL SYSTEMS AND EXTINGUISH ALL SMOKING MATERIALS. DO NOT IMMEDIATELY OPEN THE ENGINE COMPARTMENT!! THIS FEEDS OXYGEN TO THE FIRE AND FLASHBACK COULD OCCUR.**

## 4. CANVAS

**⚠ DANGER**

If the cockpit is totally enclosed with canvas covers and curtains while engine is running or boat is moving, carbon monoxide will build up and cause death or permanent injury.

Do not use the rear (aft) curtain or camper top while engine is running or boat is moving.

**⚠ DANGER**

In rainy and/or cold weather, fresh air must circulate through boat to avoid carbon monoxide poisoning.

See Section 1.3, Carbon Monoxide, for more details.

## SECTION 7 • OPTIONS & ACCESSORIES

### **⚠ DANGER**

Exhaust fumes from engines contain deadly carbon monoxide gas (CO). Boats with canvas or with poor ventilation are most likely to collect fumes.

CO sickness symptoms include headache, nausea and dizziness. Do not mistake these symptoms for sea sickness.

Ventilate boat. See Section 1.3, Carbon Monoxide, for more details.

Bimini Top or sunshade must not be used when the vessel speed exceeds 45 MPH. Damage to boat or bimini may occur.

Removing or installing canvas on the water can be difficult since rough water or wakes can cause you or your passengers to lose their balance while attempting canvas removal or installation.

For safety and ease of installation and removal of canvas, use at least two people.

The following canvas options are available for the H2X:

- Cockpit Cover
- Mooring Cover
- Trailering Cover

### **A. CANVAS CARE AND MAINTENANCE**

See Section 9, page 9.2, for instructions on the care and maintenance of your canvas.

### **B. TRAILERING WITH CANVAS**

To trailer your boat with the cockpit cover installed, you must install a mooring cover over the cockpit cover with tie down straps tightened.

## **5. HORN**

### **ELECTRIC HORN**

The horn is operated by a switch on the dash and is protected by a fuse under the dash. There is no maintenance required on the horn itself, although it is advisable to avoid spraying water directly into the horn.

H2X®

## **6. SWIM PLATFORM W/ LADDER**

Your H2X may have a swim platform installed with a ladder.

With this option, entering the boat from the water is more convenient, but there are safety rules that must be followed.

1. Never sit on the swim platform when boat is moving.
2. Before using or extending the ladder, make sure engine is off and prop is stopped.
3. It may be difficult to extend the ladder while in the water so it important to leave the ladder down if swimmers are in the water.
4. Always make sure ladder is secure before starting engine.

### **⚠ DANGER**

**MAKE SURE ENGINE IS OFF AND PROPELLER IS STOPPED BEFORE USING BOARDING LADDER**

## **7. DEPTH FINDER (OPTIONAL)**

The depth finder that may be installed in your boat is a high-performance digital sonar (See Figure 7.3.1). It works only off the bottom signal and operation is completely automatic. There are no sensitivity or noise controls. All this is made possible by the computer built inside.

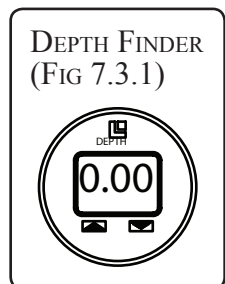

Since the depth finder is an automatic sonar, all you have to do is turn the power on. It will give you a water depth reading within seconds. Once it finds the bottom, the depth finder locks on to it and automatically adjusts the sensitivity and noise suppression circuits. It will track the bottom at speeds over 70 MPH.

Do not rely on the depth finder to determine a safe depth for swimming. The depth finder reads from the middle of the boat, not the back or front.

## SECTION 7 • OPTIONS & ACCESSORIES

REFER TO OWNER'S MANUAL PACKET FOR INSTRUCTIONS AND WARRANTY INFORMATION ON DEPTH FINDER.

### 8. STEREO SYSTEM

Your H2X comes with a Clarion CMD4 AM/FM stereo package from Marine Audio. Clarion's CM design eliminates the need for after-market housing kits or splash covers, while the silicon oil-dampened suspension ensures smooth tracking and dependable marine performance.

#### **STANDARD PERFORMANCE SYSTEM**

- CMD4 AM/FM CD Stereo
- 6 Marine Speakers
- Amplifier—2 Channel

#### **OPTIONAL PERFORMANCE SYSTEM**

- CMD4 AM/FM CD Stereo
- 6 Marine Speakers
- Amplifier—2 Channel
- Marine Subwoofer
- Remote Control

### 9. HEAD SYSTEMS

Your Baja® may be available with 3 different head system options. You should be aware of which option(s) your boat is equipped with and read the sections pertaining to it. The Owner's Manual Packet in your boat contains information pertaining to your head system that should be carefully read.

#### **A. REQUIREMENTS FOR OPERATORS**

The Environmental Protection Agency (EPA) standards state that in freshwater lakes, freshwater reservoirs or other freshwater impoundments whose inlets or outlets are such as to prevent the ingress or egress by vessel traffic subject to this regulation, or in rivers not capable of navigation by interstate vessel traffic subject to this regulation, marine sanitation devices certified by the U.S. Coast Guard installed on all vessels shall be designed and operated to prevent the overboard discharge of sewage, treated or untreated, or of any waste derived from sewage. The EPA standards further state that this shall not be construed to prohibit the carriage of Coast Guard-certified flow-through

treatment devices which have been secured so as to prevent such discharges. They also state that waters where a Coast Guard certified marine sanitation device permitting discharge is allowed include coastal waters and estuaries, the Great Lakes and interconnecting waterways, freshwater lakes and impoundments accessible through locks, and other flowing waters that are navigable interstate by vessels subject to this regulation (40 CFR 140.3).

#### **B. PORTABLE HEAD WITH PUMP-OUT**

The portable head unit has two individual holding tanks. The top tank is fitted with a hand pump and holds fresh water and chemicals. The bottom tank is for holding waste material (See Figure 7.4.1). There is an option for a dockside pump-out hose attached to the waste material (bottom) tank. The pump-out hose leads to the waste pump-out opening on the starboard side of the transom. To empty the holding tank, the services of a dockside pump-out station are needed. Follow instructions at the station and make sure the pump-out station hose is inserted into the deck plate marked "Waste."

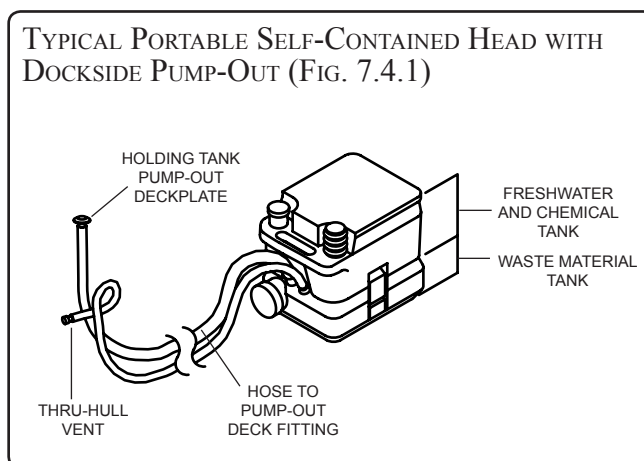

**NOTE:** Before leaving the dock make sure caps on top and bottom tanks are tight. Make sure top tank is filled with chemicals and the bottom tank is empty.

DETAILED OPERATING INSTRUCTIONS AND WARRANTY INFORMATION ARE PROVIDED BY THE EQUIPMENT MANUFACTURER AND CAN BE FOUND IN THE OWNER'S PACKET.

---

## SECTION 7 • OPTIONS & ACCESSORIES

---

### C. HOLDING TANK OPERATION

Waste from the head is directed into the holding tank located in the engine room. The holding tank fluid level indicator is located on the main distribution panel or in the head which indicates 3/4 FULL, FULL and DO NOT FLUSH, or on some models may read FULL, 1/2, or EMPTY. When the FULL light is on, the DO NOT FLUSH light will also be on. When these lights are ON, the holding tank must be emptied before the head can be reused.

### D. VENT FILTER

The vent filter is designed to control odors associated with the head system operations. The vent filter is located on the holding tank. **The filter must be changed at the beginning of each boating season to be effective.** The vent filter is installed in-line on the holding tank ventilation hose.

**Note:** Do not over fill the holding tank as this will flood the vent filter and render it useless. Filter replacement will then be required. See Parts Manual for correct replacement filter.

## 10. EXHAUST SYSTEMS

Your boat comes with a choice of different exhaust systems. Below is a description of the standard and optional systems on your H2X.

**Thru-Hub Exhaust (standard):** Thru-hub exhaust propellers consist of a round barrel to which the blades are attached. The exhaust passes through the barrel and out the back, without making contact with the blades. This provides a good clean water flow to the blades, usually resulting in good acceleration and hole shot.

**Corsa™ Performance Quick & Quiet II (option):** A full time, non-switchable, thru-hull exhaust system that uses patented Silencer Tips with a pair of upper exhaust splitters connected to the lower wishbone and the exhaust riser.

**Corsa™ Performance Quick & Quiet Plus (option):** An electronically operated exhaust diverter used in conjunction with the same Silencer Tips of the Quick & Quiet II system, but with the

added flexibility to switch the exhaust flow to fully silenced, thru-prop operation. The switch is used to change the exhaust exits, either thru-prop or thru-hull, which will provide maximum performance or minimum exhaust sound.

Many areas regulate noise limits. Even if there are no laws, courtesy demands that boats operate quietly.

# SECTION 8 • REQUIRED INSPECTION, SERVICE, & MAINTENANCE

Routine inspection, service and maintenance of your boat's systems are vital to assure your safety, as well as for prolonging the life of your boat. You should develop regular routines for inspecting your boat. The chart below summarizes inspection, service and maintenance activities. This section also contains descriptions of some convenient methods for evaluating the condition of some of your boat's systems.

The interval between necessary service or maintenance is highly variable, depending on the environment your boat is in, and on the severity of operating conditions. For example, corrosion of parts on boats operated in salt water proceeds much faster than the corrosion of parts on a boat operated in fresh water. The intervals listed below are recommended maximums, and you must reduce the time between inspections if your observations indicate the need.

## 1. SUMMARY GUIDE FOR INSPECTION, SERVICE AND MAINTENANCE

ITEM	REQUIRED MAINTENANCE/SERVICE	REFERENCE SOURCE	INTERVAL				
			BEFORE EVERY USE	AFTER FIRST 20 HOURS	EVERY 25* OR 50 HOURS	EVERY 50* OR 100 HOURS	EVERY 6 MOS. OR ANNUALLY
<b>Battery</b>	Check water level	Owner's Manual p. 6.1	•	•	•		
<b>Bilge Area</b>	Clean and check	Owner's Manual p.8.4					•
<b>Bilge Blowers</b>	Hose connections tight	Owner's Manual p. 4.2					•
<b>Bilge Pump</b>	Float switch operates freely	Owner's Manual p. 4.1					•
<b>Canvas</b>	Clean	Owner's Manual p. 9.3	<b>As Needed</b>				
<b>CO Monitor</b>	Check for proper operation	Owner's Manual p. 1.3	<b>Check before each use</b>				
<b>Controls</b>							
<i>Steering</i>	Check for proper operation		<b>To be done by Baja dealer every six months</b>				
	Power steering oil level	Engine Manual	•				
<i>Throttle</i>	Lubricate - include all shift	Engine Manual		•		•	•
	Linkage and pivot points						
<b>Electrical</b>							
<i>Connections</i>	Check for looseness		<b>To be done by Baja dealer annually</b>				
<b>Engine</b>							
<i>Alarm</i>	Check	Engine Manual	•				
<i>Cooling System</i>	Check for leaks	Engine Manual	•				
<i>Connections</i>	with engine running						
<i>Crank Case ventilating system</i>	Clean	Engine Manual		•		•	
<i>Drive Belts</i>	Check	Engine Manual	•				
<i>Exhaust System</i>	Check for leaks	Engine Manual	•	•		•	
<i>Flame Arrestor</i>	Clean	Engine Manual		•		•	
<i>Fuel Filter</i>	Replace	Engine Manual				•	
<i>Mounts (Fasteners)</i>	Tighten	Engine Manual		•			•
<i>Oil and Filter</i>	Replace	Engine Manual				•	•
<i>Oil Level</i>	Check	Engine Manual	•				
<b>Fuel System</b>							
<i>Connections &amp; lines</i>	Check for leaks	Engine Manual	•	•	•		
<i>Tanks</i>	Check for leaks	Owner's Manual, Sec. 5	•	•	•		

\*Use in salt water or other severe operating conditions requires shorter maintenance/service intervals

\*\*May not be on your boat



# SECTION 8 • REQUIRED INSPECTION, SERVICE, & MAINTENANCE

## SUMMARY GUIDE FOR INSPECTION, SERVICE AND MAINTENANCE

ITEM	REQUIRED MAINTENANCE/SERVICE	REFERENCE SOURCE	INTERVAL				
			BEFORE EVERY USE	AFTER FIRST 20 HOURS	EVERY 25* OR 50 HOURS	EVERY 50* OR 100 HOURS	EVERY 6 MOS. OR ANNUALLY
<b>Propeller</b>	Inspect for damage		<b>Always after striking object</b>				
<b>Seaworthiness</b>							
<i>Bilge drain plug</i>	Installed and tight	Owner's Manual p. 4.1	•				
<i>Hull damage Stern drive</i>	Check for loose, damaged or missing parts		<b>Always after striking object</b>				
<b>Stern Drive</b>							
<i>Fluid level</i>	Check level	Engine Manual	•				
<i>Fluid</i>	Replace	Engine Manual					•
<b>Topside &amp; Supplies</b>	Check for loose, damaged or missing parts	Owner's Manual p. 8.5					•
<b>Trim Tabs</b>							
<i>Fluid</i>	Check and add as needed	Trim Tab Manual		•			
<b>Zincs (Also see Mercathode System**)</b>							
<i>Stern drive</i>	Check and replace as needed	Owner's Manual p. 6.3	<b>Every 25 hours of operation</b>				
<i>Trim Tabs</i>	Check fluid level	Trim Tab Manual	<b>Every 25 Hours of operation</b>				

\*Use in salt water or other severe operating conditions requires shorter maintenance/service intervals

\*\*May not be on your boat

---

# SECTION 8 • REQUIRED INSPECTION, SERVICE, & MAINTENANCE

---

## 2. USEFUL SERVICE INFORMATION

OWNER \_\_\_\_\_

HOME PORT \_\_\_\_\_

BOAT NAME \_\_\_\_\_

REGISTRATION NUMBER \_\_\_\_\_ STATE \_\_\_\_\_

HULL SERIAL NUMBER \_\_\_\_\_

WARRANTY REGISTRATION DATE \_\_\_\_\_

ENGINE MAKE & MODEL \_\_\_\_\_

SERIAL NUMBER \_\_\_\_\_

GEAR MAKE & REDUCTION RATIO \_\_\_\_\_

SERIAL NUMBER \_\_\_\_\_

PROPELLER SIZE \_\_\_\_\_

PART NUMBER \_\_\_\_\_

SHAFT SIZE (DIAMETER X LENGTH) \_\_\_\_\_ MATERIAL \_\_\_\_\_

FUEL CAPACITY \_\_\_\_\_

WATER CAPACITY \_\_\_\_\_

KEY NUMBER, IGNITION \_\_\_\_\_ DOOR \_\_\_\_\_

SELLING DEALER \_\_\_\_\_

CITY & STATE \_\_\_\_\_

LENGTH \_\_\_\_\_ BEAM \_\_\_\_\_ DRAFT \_\_\_\_\_

VERTICAL CLEARANCE \_\_\_\_\_

ESTIMATED WEIGHT \_\_\_\_\_

---

# SECTION 8 • REQUIRED INSPECTION, SERVICE, & MAINTENANCE

---

## 3. INSPECTION, SERVICE AND MAINTENANCE PROTOCOL

### A. BILGE AREA

Many of your boat's systems have critical features located in the bilge area. A thorough and organized inspection of the bilge area will address many of these critical features. For example, engine oil leaks and fuel system leaks will show themselves as contamination on the surface of the liquid that remains in the bilge. When you see such contamination, you should look for its source.

Once or twice a year, pump the bilge areas dry and remove all loose dirt. Be sure that all the limber holes are open. Limber holes are the openings in the stringers that allow water to flow from the outboard areas of the bilge to the bilge sump.

Check the bilge pump float switch by moving it manually. (Figure 4.1.2) The bilge pump should start when the float switch is raised and should stop when lowered. If it does not, have it replaced before using your boat. The float switch should also move freely without sticking, if it does not, have it serviced or replaced before boating.

#### WARNING

**DO NOT USE FLAMMABLE SOLVENTS** to clean any part of the bilge.

**Fumes can accumulate and can be the source of an explosion.**

### 1. OIL

If there is oil contamination, look for leaks in engine oil lines and engine gaskets. If parts of the bilge have been stained by oil, the stain can be removed using a bilge cleaner available from your dealer or a marine store.

#### WARNING

**Work on electrical wiring can create shock hazards or sparks.**

**Always shut off battery switch, breakers and/or pull fuses before checking electrical wiring or connectors.**

### 2. ENGINE

Engine failure or malfunction, when away from shore, can be dangerous. Make certain you do the following each time you use the boat:

- Wipe off the engine to remove accumulated dust, grease and oil.
- Check all exposed nuts, bolts and screws for tightness.
- Inspect the belts for wear. If they do not require replacement, check and adjust the belt tension according to the engine manufacturer's recommendation.
- Inspect engine wiring, and clean and tighten the terminals on the engine electrical system.
- Clean and lubricate the battery cables.
- Add distilled water to the battery cells as needed.
- Refer to your Engine Operator's Manual for additional engine maintenance requirements.

### 3. FUEL SYSTEM

- Inspect the entire fuel system for evidence of leakage, including the fuel tank fill lines and vents. Any stain around a joint could be an indication of a leak.
- Test all fittings with a wrench to be sure they are not loose, but do not forcefully overtighten the fittings.
- Clean fuel filters and vent screens.

---

# SECTION 8 • REQUIRED INSPECTION, SERVICE, & MAINTENANCE

---

## 4. WIRING SYSTEM

- Check all wiring for proper support.
- Check all wiring insulation for signs of fraying or chafing.
- Check all terminals for corrosion - corroded terminals and connectors should be replaced or thoroughly cleaned.
- Tighten all terminals securely and spray them with light marine preservative oil.

## 5. FITTINGS, HOSES AND CLAMPS

- Inspect the entire bilge area for evidence of damage or deterioration. Evidence of deterioration will first appear around hull fittings, hoses and clamps.
- Straighten kinked hoses.
- Replace any hose that does not feel pliable.
- Check all hose clamps for tightness and corrosion. Corroded clamps must be replaced.
- Check the nuts, bolts and screws that retain equipment, hoses, etc. in the bilge for tightness and corrosion. Corroded fasteners must be replaced.

## B. TOPSIDE AND SUPPLIES

Once a year, you should undertake a thorough review of the topside equipment, as well as of the critical safety supplies on your boat.

- Check cleats, rings, rails, etc. for loose or corroded fasteners, breaks, sharp edges, or other conditions that could lead to malfunction or unsafe use. Repair or replace as necessary.
- Inspect PFDs (life jackets) for tears and deterioration.
- Make certain you have enough PFDs on board for the maximum number of persons you can carry.

- Check your first aid kit, making certain it is complete and that the items in it have not passed an expiration date.
- Check the signaling equipment and emergency flares. Make sure all items are within their expiration dates.
- Inspect the anchor, mooring, and towing lines. Repair or replace as required.
- Check fire extinguishers for full charge.

## 4. WINTERIZATION CHECKLIST FOR BOATS STORED ON LAND

### A. BOAT STORAGE

- Store boat in a bow high attitude.
- Remove hull drain plug.
- Pour one (1) pint (half-liter) of 50% water/antifreeze mixture in each bilge pump sump.

### B. ENGINE

- Flush engine with fresh water.
- Remove engine drain plugs.

REFER TO YOUR ENGINE OPERATOR'S MANUAL FOR DETAILED INFORMATION ON PREPARING THE ENGINES FOR STORAGE AND WINTERIZATION.

### C. BATTERY(IES)

- Remove from boat. Remove the negative (-) cable first, then the positive (+) cable.
- Remove grease and dirt from top surface.
- Grease terminal bolts.
- Store on wooden pallet or thick plastic in a cool dry place. Do not store on concrete.

---

# SECTION 8 • REQUIRED INSPECTION, SERVICE, & MAINTENANCE

---

- Keep under a trickle charge.
- When placing battery back into service, remove excess grease from terminals, recharge as necessary and reinstall in boat.

## D. FUEL SYSTEMS

### GASOLINE:

- Fill fuel tank with gasoline and the recommended amount of stabilizer and conditioner such as “Stabil®”.
- Run engine(s) for ten minutes to ensure that all gasoline in the carburetor and fuel lines are treated.

### DIESEL:

- Fill fuel tank with diesel and recommended amount of biocide, “Biobor®”, which prevents bacteria and fungi from contaminating diesel fuel that contains some water.
- Diesel fuel should also get a petroleum distillate additive, such as “Stabil®” or Racor® RX100”. This will absorb water in the fuel and prevent freezing problems.
- Run engine(s) for ten minutes to ensure that all diesel fuel in injectors and fuel lines is treated.

DETAILED WINTERIZING, OPERATING INSTRUCTIONS AND WARRANTY INFORMATION ARE PROVIDED BY THE EQUIPMENT MANUFACTURER AND CAN BE FOUND IN THE OWNER’S PACKET.



### CAUTION

Do not overfill. Filling a tank until the fuel flows from vents is dangerous. Allow room for expansion.

## 5. FITTING OUT AFTER STORAGE

### A. FUEL SYSTEM

Check the entire fuel system for loose connections, worn hoses, leaks, etc. and repair. This is a primary safety precaution.

Check fuel lines for damage and make sure that they do not come in contact with any moving parts.

### B. BATTERY(IES)

Before installing the batteries, clean the terminal posts with a wire brush or steel wool and then attach the cables. After the cable clamps are tightened, smear the post and clamps with vaseline or grease to exclude air and acid. Do not apply grease before attaching and tightening the terminal clamps. Examine all wiring.

### C. MISCELLANEOUS

- Check all thru-hull fittings for unobstructed water passage. Be alert for any deteriorated hoses and/or fittings below the water line which might fail in service and allow water.
- Test the navigation lights.
- Check all wiring for loose connections.
- Check all switches and equipment for proper operation.
- Check bilge blowers for proper operation. Turn on blowers and place hand over hull blower vent to make sure air is coming from vent.
- Anchor lines and gear should be inspected and replaced if necessary.
- Make sure the hull drain plug is in place and tight.
- Clean bilge thoroughly if it was not done at lay-up.
- Check all engine fluid levels.

---

# SECTION 8 • REQUIRED INSPECTION, SERVICE, & MAINTENANCE

---

- Check fuel lines for damage and/or leaks. Make sure that they do not come into contact with moving parts.
- Check Carbon Monoxide detector to see if operational

## 6. SECURITY CONSIDERATIONS

Be conscious of the security of your boat. Always remove the keys from the ignition, lock hatches, lock the cabin door, remove and stow any removable electronic gear (fishfinders, LORAN, etc.) and personal gear (fishing poles, etc.) normally left aboard your boat.

## 7. POWER STEERING SYSTEM

### MAINTENANCE

- Lubricate the control valve on the power steering cylinder through the grease fitting with multipurpose lubricant until grease appears around the rubber boot.
- Coat power assist steering output shaft and exposed steering cable end with appropriate lubricant.
- Lubricate cable end guide pivot point with SAE 30W engine oil.
- Check power steering fluid level in the power steering pump reservoir.
- Inspect all hydraulic hoses for leaks. Keep hoses from rubbing on moving parts and from contact

with hot engine parts.

- Check all fittings, clamps, and bolts for tightness every month.
- Check power steering pump drive belt for wear and proper tension every month. Do not overtighten belt. This can cause bearing failure.

REFER TO THE ENGINE OPERATOR'S MANUAL FOR PROPER FLUID LEVELS AND LUBRICANTS.

Baja® Marine recommends that all repairs and/or replacements to steering systems be made by qualified dealers authorized by manufacturer of the steering system of your boat.

DETAILED OPERATING INSTRUCTIONS AND WARRANTY INFORMATION ARE PROVIDED BY THE EQUIPMENT MANUFACTURER AND CAN BE FOUND IN THE OWNER'S PACKET.

---

# SECTION 8 • REQUIRED INSPECTION, SERVICE, & MAINTENANCE

---

## 8. QUICK REFERENCE CHECKLIST

As the owner/operator of a Baja® Boat, you are responsible for the safe operation of your boat and the safety of your passengers. Always be sure that required documents, navigational equipment and Coast Guard required safety equipment is aboard and in proper working order.

### A. BOARDING THE BOAT\*

#### GENERAL

1. Weather Conditions ..... Is it going to be safe to go out
2. Transom Drain Plug..... Installed
3. PFDs and all other Coast Guard required safety equipment..... Available for all children and adults
4. Ignition keys..... Available
5. Tool Box..... Stocked with a variety of appropriate tools
4. Fire Extinguisher..... Available
5. Cell Phone..... Fully charged

#### BOAT SYSTEMS

1. Bilge Pumps ..... Working. Discharge any appreciable amounts of water overboard
2. Blowers..... Working. "Sniff" the bilge/engine compartment for fuel odor
3. Navigation Lights..... Working. Have spare bulbs (and if applicable fuses) aboard
4. Radio/Electronics..... Working
5. Horn..... Working
6. Trim Tabs ..... Full range of motion. No excessive play or binding
7. Fresh Water Tank ..... Filled and sanitized
8. Carbon Monoxide Detector..... Working

#### ENGINE

1. Batteries ..... Fully charged (Check water cell levels)
2. Fuel Tank ..... Filled with recommended fuel; not leaking
3. Fuel System..... Check for leaks
4. Fuel Filters..... Check that filters are clean and tight
5. Diesel Racor Fuel Filters ..... Check that filters are clean, tight and free of water
6. Engine Coolant Drain Plugs ..... Secured
7. Steering Fluid ..... Full
8. Throttle & Gearshift Controls ..... Full range of motion

\*Note: If trailering boat, many of these items should be checked before leaving the house.

---

# SECTION 8 • REQUIRED INSPECTION, SERVICE, & MAINTENANCE

---

## QUICK REFERENCE CHECKLIST (CONT'D)

### B. PREPARING TO DEPART AND AFTER LAUNCHING

#### GENERAL

1. Bilge/Engine Compartment..... “Sniff” the bilge/engine compartment for fuel odor. Run the bilge blowers for at least four (4) minutes.
2. Shore Power Cable ..... Disconnected from dockside power inlet
3. Lines, Fenders and Anchor..... Ready for use
4. Passengers/Crew ..... Instructed in duties for getting underway and fitted for a correct size PFD

#### ENGINE

1. Battery Switches..... In the ON position
2. Fuel Valves (Diesel Only) ..... Open
3. Engine Alarm ..... Test. Should sound after a few seconds
4. Gear Shift & Throttle Controls ..... In NEUTRAL and IDLE positions

#### STARTING THE ENGINE\*

1. Gearshift & Throttle Controls ..... Shift in NEUTRAL (Refer to your Engine Owner’s Manual for startup procedures for your specific engine)
2. Ignition ..... Turn ignition keys on the helm clockwise until engine starts, then release.

**IMPORTANT: Do not continue to operate starter for more than 10 seconds without pausing to allow starter motor to cool off for 2 minutes. This also will allow the battery to recover between starting attempts.\***



#### WARNING

Do not run the engine or generator in an enclosed area, such as a closed boat house, as there is the possibility of buildup and inhaling of carbon monoxide.

\*If engine fails to start, refer to the Engine Owner’s Manual for further troubleshooting procedures



---

# SECTION 8 • REQUIRED INSPECTION, SERVICE, & MAINTENANCE

---

## QUICK REFERENCE CHECKLIST (CONT'D)

### C. DEPARTING

#### GENERAL

1. Passengers/Crew ..... Safely seated with PFDs on or immediately accessible
2. Lines, Fenders and Anchor..... Stowed

#### BOAT SYSTEMS

1. Trim Tabs ..... Bring boat to “on plane” – Adjust as necessary
2. Navigation Lights ..... On at night or in reduced visibility

#### ENGINE

1. Tachometers ..... Engines operating in safe RPM range
2. Engine Gauges ..... Continually monitor
3. Engine Operation..... Check idle and shift. Listen for abnormal noises and visually check the engine compartment.

### D. RETURNING TO PORT

#### GENERAL

1. Passengers/Crew ..... Instructed in duties for line handling
2. Lines and Fenders..... Ready for use

#### BOAT SYSTEMS

1. Navigation Lights ..... Turned OFF when secured
2. Anchor Light ..... ON if necessary
3. Bilge/Engine Compartment..... “Sniff” the bilge/engine compartment for fuel odor. Run the bilge blowers if necessary. Check for water in bilge. Run bilge pumps if necessary

#### ENGINE

1. Gearshift & Throttle Controls ..... Bring to NEUTRAL and IDLE positions
2. Tachometers ..... Idle the engines for five (5) minutes to cool down

---

# SECTION 8 • REQUIRED INSPECTION, SERVICE, & MAINTENANCE

---

## QUICK REFERENCE CHECKLIST (CONT'D)

3. Ignition ..... Once the motor is cooled down, turn the ignition keys counter clockwise to stop the engine.
4. Engine Operation..... Check idle and **shift**. **Listen for** abnormal noises

## E. SECURING THE BOAT

### GENERAL

- Lines and Fenders ..... Fenders in place, lines tied securely to dock

### BOAT SYSTEMS

1. Helm Switch Panel ..... All switches in the OFF position
2. Gearshift & Throttle Controls ..... In the NEUTRAL and IDLE positions

### ENGINE

1. Ignition ..... Switch is in the OFF position and ignition keys are removed
2. Battery Switches..... In the OFF position
3. Fuel Valves (Diesel Only) ..... Closed (handle perpendicular to hose)

## F. IF THE ENGINE DOES NOT START

### NO STARTER MOTOR RESPONSE

1. Check battery switch is in the ON position.
2. Check the main circuit breaker.
3. Check gearshift/throttle control levers in the NEUTRAL positions.
4. Check battery condition for sufficient charge.
5. Check battery cable connections tight and free from corrosion.
6. Check starter motor and solenoid connections.
7. Check ignition switch connections.
8. Consult the engine manual that is located in the owners packet.

### STARTER MOTOR RESPONDS, BUT NO IGNITION

1. Check that fuel tank is not empty.
2. Check that ignition shutdown switch lanyard is installed.
3. Check electrical connections on engine wiring harness and ignition wiring.
4. Check fuel filters and filter/water separators clean
5. Consult the engine manual that is located in the owners packet.

---

# SECTION 8 • REQUIRED INSPECTION, SERVICE, & MAINTENANCE

---

## 9. AFTER MARKET EQUIPMENT CHECKLIST

Any safety or operational equipment added to your boat after delivery should be checked for seaworthiness and proper working condition. Use the area below to list any equipment and the proper operating condition of that equipment before getting underway.

**Equipment**

**Proper Operating Condition**

_____	_____
_____	_____
_____	_____
_____	_____
_____	_____
_____	_____
_____	_____
_____	_____
_____	_____
_____	_____
_____	_____
_____	_____
_____	_____
_____	_____
_____	_____
_____	_____
_____	_____
_____	_____
_____	_____
_____	_____
_____	_____







## SECTION 9 • CARE & REFINISHING

Your new boat has been designed to provide you with years of enjoyment and satisfaction. In order to maintain the factory new appearance of your boat, we recommend the use of Yacht Bright™ products designed specifically for pleasure boats. Following proper fiberglass maintenance guidelines will help maintain your boat's performance, value, and enjoyment.

### 1. PAINT CLEANING AGENTS & OTHER SUBSTANCES

**! WARNING**

**EXPLOSION/FIRE HAZARD**

Care and refinishing materials may contain ingredients that are flammable or explosive. Do not use such materials in the bilge

Shut off electrical power and ventilate when using such materials anywhere on the boat or in the cabin.

Do not create sparks or use lighted materials.

Do not use products containing chlorine, phosphates, perfumes and non-degradable ingredients. Consult your marine dealer regarding environmental regulations before painting the hull. Fumes can last for hours, and chemical ingredients can harm people, property and the environment. Common household cleaning agents may cause hazardous reactions. Read and understand directions on all paint, cleaning and polishing materials before using.

### 2. FIBERGLASS & GELCOAT

The fiberglass hull, deck and some interior parts consist of a molded shell and exterior gelcoat. The gelcoat is the outer surface, often colored, that presents the shiny smooth appearance associated with fiberglass products. This gelcoat surface is painted or taped in some areas for styling purposes.

Wash the gelcoat and fiberglass regularly with clean, fresh water. Wax gelcoated surfaces to maintain the luster. In northern climates, a waxing at the start and end of the boating season may suffice. In southern climates, an application of wax every three months will be required for adequate protection.

REFER TO THE YACHT BRIGHT™ PAMPHLET IN YOUR OWNER'S MANUAL PACKET FOR INSTRUCTIONS AND WARRANTY INFORMATION.

### 3. STAINS & SCRATCHES

**! WARNING**

Gelcoat surfaces are slippery when wet.

Always wear non-slip footwear securely fastened to your feet and hold on to rails or the boat structure.

**! WARNING**

Waxed surfaces are slippery.

Do not wax areas that are usually walked on.

Although gelcoat and painted surfaces are resistant to deep stains, a need for cleaning will occasionally arise. But, the use of some common cleaning agents will permanently discolor or otherwise damage the finish on your boat.

- Do not use abrasive porcelain-cleaning powders. These are too abrasive and contain chlorine and ammonia, either of which will permanently discolor gelcoat and paint.
- Never use nail polish remover (acetone) or any ketone solvents.
- Use diluted household detergents to remove surface soil and stains. Before using a given brand, check to make sure it contains no chlorine or ammonia.
- Isopropyl alcohol can be used to remove difficult stains. But it must be promptly washed off with mild detergent and water.

---

## SECTION 9 • CARE & REFINISHING

---

- Minor scratches and deeper stains that do not penetrate the gelcoat may be removed by light sanding and buffing.

### 4. PERMANENTLY MOORED OR DOCKED BOATS

If permanently moored in salt water or fresh water, your boat will collect marine growth on its bottom. This will detract from the boat's beauty and greatly affect its performance. There are two methods of preventing this:

- Periodically haul the boat out of the water and scrub the bottom with a bristle brush and a solution of soap and water.
- Paint the hull below the waterline with a good grade of antifouling paint. **DO NOT paint the engine drive surfaces.**

**NOTE:** There are EPA regulations regarding bottom paint application. Consult your Baja® dealer for proper application methods.

### 5. TOPSIDE AREAS

#### A. STAINLESS STEEL AND ALLOY FITTINGS

Stainless steel and alloy fittings should be cleaned with soap and water or household glass cleaner. Remove rust spots as soon as possible with a brass, silver or chrome cleaner. Irreversible pitting will develop under rust that remains for any period of time. Never use an abrasive like sandpaper or steel wool on stainless. These may actually cause rust. To help protect the stainless, we recommend the use of a good car wax.

#### B. SALT CRYSTALS

When instruments are exposed to a saltwater environment, salt crystals may form on the bezel and the plastic covers. These salt crystals should be removed with a soft, damp cloth; never use abrasives or rough, dirty cloths to wipe plastic parts. Mild household detergents or plastic cleaners can be used to keep the instruments bright and clean. **Refer to the Owner's Manual Packet for instructions and warranty information.**

### 6. ACRYLIC PLASTIC SHEETING (PLASTIC GLASS)

**Never use a dry cloth or duster or glass cleaning solutions on acrylic.**

To clean acrylic, first flood it with water to wash off as much dirt as possible. Next, use your bare hand, with plenty of water, to feel and dislodge any caked dirt or mud. A soft, grit-free cloth may then be used with a nonabrasive soap or detergent. A soft sponge, kept clean for this purpose, is excellent. Blot dry with a clean damp chamois.

Grease and oil may be removed from acrylic with kerosene, hexane, white (not aviation or ethyl) gasoline or aliphatic naphtha (no aromatic content).

**Do not use solvents such as acetone, silicone spray, benzene, carbon tetrachloride, fire extinguisher fluid, dry cleaning fluid or lacquer thinner on acrylic, since they attack the surface.**

Remove fine scratches with fine automotive acrylic rubbing and polishing compounds.

### 7. CANVAS AND CLEAR VINYL

**Do not fold or store any of the canvas pieces while wet.** All canvas should be rolled or folded when dry and stored in a clean, dry place. For clear vinyl pieces, the recommended methods for storage are rolling or laying down flat. The clear vinyl should never be folded or creased as cracking will result. To protect the clear vinyl from rubbing against itself while rolled or stored flat, place a piece of very soft, nonabrasive cloth between the pieces. If the surface of the clear vinyl becomes scratched, the canvas manufacturer has provided a canvas care sheet located in your Owner's Manual Packet. When storing the rear (aft) curtain, fold the canvas over the clear vinyl window (do not fold clear vinyl), then roll or store flat. **REFER TO THE CANVAS CARE INSTRUCTIONS IN THE OWNER'S MANUAL PACKET.**

---

## SECTION 9 • CARE & REFINISHING

---

The fabric should be cleaned regularly before substances such as dirt, pollen, etc. are allowed to accumulate on and become embedded in the fabric. The fabric can be cleaned without being removed from the installation. Simply brush off any loose dirt, particles, etc.; hose down and clean with a mild solution of a natural soap in lukewarm water (no more than 100°F, 38°C); rinse thoroughly to remove soap. **DO NOT USE DETERGENTS.** Allow to completely dry.

Wash and clean vinyl windows with a warm soap solution. Use a soft cloth or sponge and do not scratch the surface.

If you have stubborn cleaning cases, call your dealer for proper procedures. Do not try your own cleaning procedures as they may permanently damage the canvas.

After each use, especially in salt water areas, rinse the canvas completely with fresh cold water. Then let the canvas dry completely before stowing.

**DO NOT**, at anytime, dry any canvas part in a conventional dryer, because shrinking may occur.

All metal components of the canvas should be rinsed with fresh cold water and exposed components wiped dry to maintain appearance and working order.

### 8. EXTERIOR UPHOLSTERY FABRIC

Exterior fabrics should be cleaned with a sponge or very soft scrub brush and a mild soap and warm water solution. After scrubbing, rinse with plenty of cold, clean water and allow the fabric to air dry in a well ventilated place, preferably away from direct sunlight.

Mildew can occur if your boat does not have adequate ventilation. Heat alone will not prevent mildew; you must also provide for fresh air circulation.

REFER TO THE OWNER'S MANUAL PACKET FOR INSTRUCTIONS AND WARRANTY INFORMATION.

### 9. INTERIOR UPHOLSTERY FABRIC

Cleaning and maintenance information, provided by the material manufacturer, is in your Owner's Manual Packet.

REFER TO THE OWNER'S MANUAL PACKET FOR INSTRUCTIONS AND OTHER CLEANING INFORMATION.

#### NOTICE

**Always clean spots, stains, etc., immediately.**

**Test an unseen area of fabric before cleaning stain, to insure that cleaning material will not cause damage.**



---

## SECTION 9 • CARE & REFINISHING

---

THIS PAGE INTENTIONALLY LEFT BLANK

---

# INDEX

---

## A

Accessories. *See* Options &  
Accessories Locations

## B

Bilge 4.1  
Blower 4.2  
Maintenance 4.2, 8.4  
Pump 4.1  
Boarding 3.3  
Breakers. *See* Electrical Systems  
Builder's Plate 1.6

## C

Canvas 7.2, 9.2  
Carbon Monoxide 1.2  
Certifications  
CE (Common European) Mark iv  
NMMA (National Marine  
Manufacturers Assoc.) iv  
Clearances 2.2

## D

Diving 1.10  
Docking 2.1

## E

Electrical Systems  
Batteries 6.1  
Breakers and/or Fuses 6.2  
Direct Current (DC) 6.1  
Electrolytic Corrosion 6.2  
Emergency Situations 1.10  
Engine  
Maintenance 8.4  
Maintenance & Service 4.2  
Starting 3.4  
Stopping 3.5  
Engine Alarm System 2.7  
Exhaust System 7.5

## F

Failure: Propulsion, Control or  
Steering 1.12  
Fiberglass, Care & Cleaning 9.1  
Fire Extinguisher 1.2  
Fire Extinguisher Port 7.2  
Fire Extinguisher System 7.2  
Fire Extinguishing System 1.2, 7.2

Flooding 1.11  
Fuel System  
Anti-Siphon Valve 5.1  
Fuel Gauge 2.8  
Fueling 3.2  
Maintenance 8.4  
Fuses. *See* Electrical Systems

## G

Gear Shift and Throttle Control 2.5  
Gelcoat, Care & Cleaning 9.1

## H

Head Systems 7.4  
Holding Tank 7.5  
Horn 7.3  
Hull  
Identification Number (HIN) iv

## I

Ignition Shutdown Switch 2.7

## L

Layout  
Deck 2.4  
Lifting 2.1  
Lights  
Navigation & Anchor 2.8  
Load Capacity 1.5

## N

Nautical Terms 1.14

## O

OEM i  
Options & Accessories Locations 7.1  
Owner's Manual Packet i

## P

Passengers  
Instruction 3.4  
Locations 2.1  
Personal Flotation Devices (PFDs)  
1.2, 1.4, 3.3  
Power Capacity 1.6  
Power Trim 2.5  
Propellers 1.6, 2.3  
Removal & Installation 4.3  
Propulsion System 2.3

## R

Recommended Equipment 1.5  
Requirements  
International Requirements 1.12  
Required Equipment 1.2

## S

Safe boating 1.1  
Safety Labels 1.1  
Security Considerations 8.7  
Service, Summary Guide 8.1  
Service Information 8.3  
Skiing 1.9  
Stability 1.6  
Stains 9.1  
Steering System 3.6  
Stern Drive 4.2  
Storage 2.1  
Swimming 1.9  
Swim Platform 7.3  
Symbols 1.15

## T

Tachometer 2.7  
Trailer 2.1  
Trailer Launching and Loading 3.2  
Trailer Switch 2.6  
Trim 2.5  
Trim Tabs 2.6

## U

U.S. Coast Guard 1.12

## V

Visual Distress Signals 1.2

## W

Warranty iii, v  
Water Sports 1.9  
Water Temperature 2.8  
Weather 1.7  
Winterization 8.5

## Z

Zinc Anodes 6.2

THIS PAGE INTENTIONALLY LEFT BLANK